

Syllabus





S Hello, friends!	Numbers 1-10 Shapes Colours Days of the week	Hello. What's your name? Goodbye. I'm (Jake).	
<div style="display: flex; justify-content: space-between;"> Vocabulary Grammar Phonics </div>			
1 Ready for school!	Classroom objects More classroom objects	Where's my (pencil)? It's here. Put the (book) on the (shelf). in / on / under	Consonant sound r : red rabbit red ruler
2 Happy birthday!	Toys Adjectives	What is it? Is it a (bike)? Yes, it is. No, it isn't. What's your favourite toy? My favourite toy is a (ball).	Consonant sound s : six snakes slow scooter
3 At the circus	Parts of the body Describing hair and eyes	I've got a (red nose). I've got (small eyes). My friend has got (long hair). He's / She's got (blue eyes).	Consonant sound h : Helen happy hippo hops
 My project 1: Family	Family members	Have you got (a brother)? Yes, I have. No, I haven't.	This is my (father / mother). His / Her name is ...
4 Fantastic food!	Food Fruit	I like / don't like (chicken). I love (ice cream). Do you like (grapes)? Yes, I do. No, I don't.	Consonant sound j : Jim juggles jam juice jelly
5 Fun on the farm	Farm animals Actions	Can you see a (cow)? Yes, I can. No, I can't. (Birds) can fly. (Cows) can't climb.	Consonant sound sh : shush! shout sheep
6 A day in the park	Playground objects and nature Prepositions of place	Where's (Beth)? He's / She's (on the swing). Where are (Jake and Molly)? They're (behind) the (tree).	Consonant sound w : Wally worm washes windows
 My project 2: Spring	Spring animals and plants	How many (lambs) can you see? I can see (seven) lambs.	This is my (butterfly). It's (blue). My (bird) is near (a bush).
7 Let's explore my town!	Places in the town Transport Numbers 11-20	There's a (zoo). There are (two sweet shops). How many (cars) are there?	Consonant sound z : lazy zebra zoo
8 Camping fun!	Clothes Outdoor activities	What are you wearing? I'm wearing (shorts) and a (T-shirt). What's he / she doing? He's / She's (riding a horse).	Consonant sound v : Vicky vet loves volleyball
9 Day and night	Daily routines Meal times	I (wash my face) every day. I have (dinner in the evening).	Consonant sound th : three thin bath Thursday
 My project 3: Holidays	Places for a holiday Holiday things	Where do you go on holiday? I go to (the beach).	I go to the (beach). It's (hot) there. I've got (a swimsuit) on my list.
Festivals	Bonfire Night	Valentine's Day	

What's this?
It's a (bike).

What colour is it?
It's (green).

What day is it today?
It's (Thursday).

Literacy	Culture	21st Century Skills	Cross-curricular links
A classroom poster	School assemblies	 21st Ways of working: being organised	Science: Tidy classroom; School subjects Arts and Crafts: Lines and shapes
A birthday card	Birthday parties in Britain	 21st Ways of thinking: ordering favourite things	Science: The senses Arts and Crafts: Patterns
An action rhyme	Circus Day	 21st Ways of working: working together	Science: Parts of the body: bones, joints and muscles Arts and Crafts: Lines and colours
Making a class family tree display 			Science: Different types of family Arts and Crafts: Art in my home
A lunch menu	A traditional English breakfast	 21st Living in the world: eating healthily	Science: Healthy food; Meals of the day Arts and Crafts: Texture
Animal riddles	Urban farms	 21st Ways of thinking: putting things in groups	Science: Farm animals and domestic animals; How animals move; Wild animals Arts and Crafts: Forms
Instructions	Parks in Britain	 21st Living in the world: being careful in the playground	Science: Living and non-living things; What plants need to survive Arts and Crafts: Geometric and organic shapes
Making a class spring wall display 			Science: Living things Arts and Crafts: Art in my world
A fable	Cycling in Britain	 21st Digital skills: reading digital maps	Science: Road safety; Rights and rules Arts and Crafts: Buildings and symmetry
A postcard	Camping in the garden	 21st Ways of thinking: thinking before you choose	Science: Human and physical elements in the environment; Clothing in different weather Arts and Crafts: Landscapes
A poem	The Tooth Fairy	 21st Living in the world: looking after your teeth	Science: Day and night; Parts of the day Arts and Crafts: Warm and cool colours
Making a holiday list display 			Science: Cardinal points; Continents and oceans Arts and Crafts: Recycled Art

1 Listen and point. Sing *I'm ready for school!*

A pen, a pencil,
A crayon, too.
I'm ready! I'm ready!
I'm ready for school!

A rubber, a ruler,
A sharpener, too.
I'm ready! I'm ready!
I'm ready for school!

A book, a school bag,
A pencil case, too.
I'm ready! I'm ready!
I'm ready for school!
Hurray! I'm ready for school!

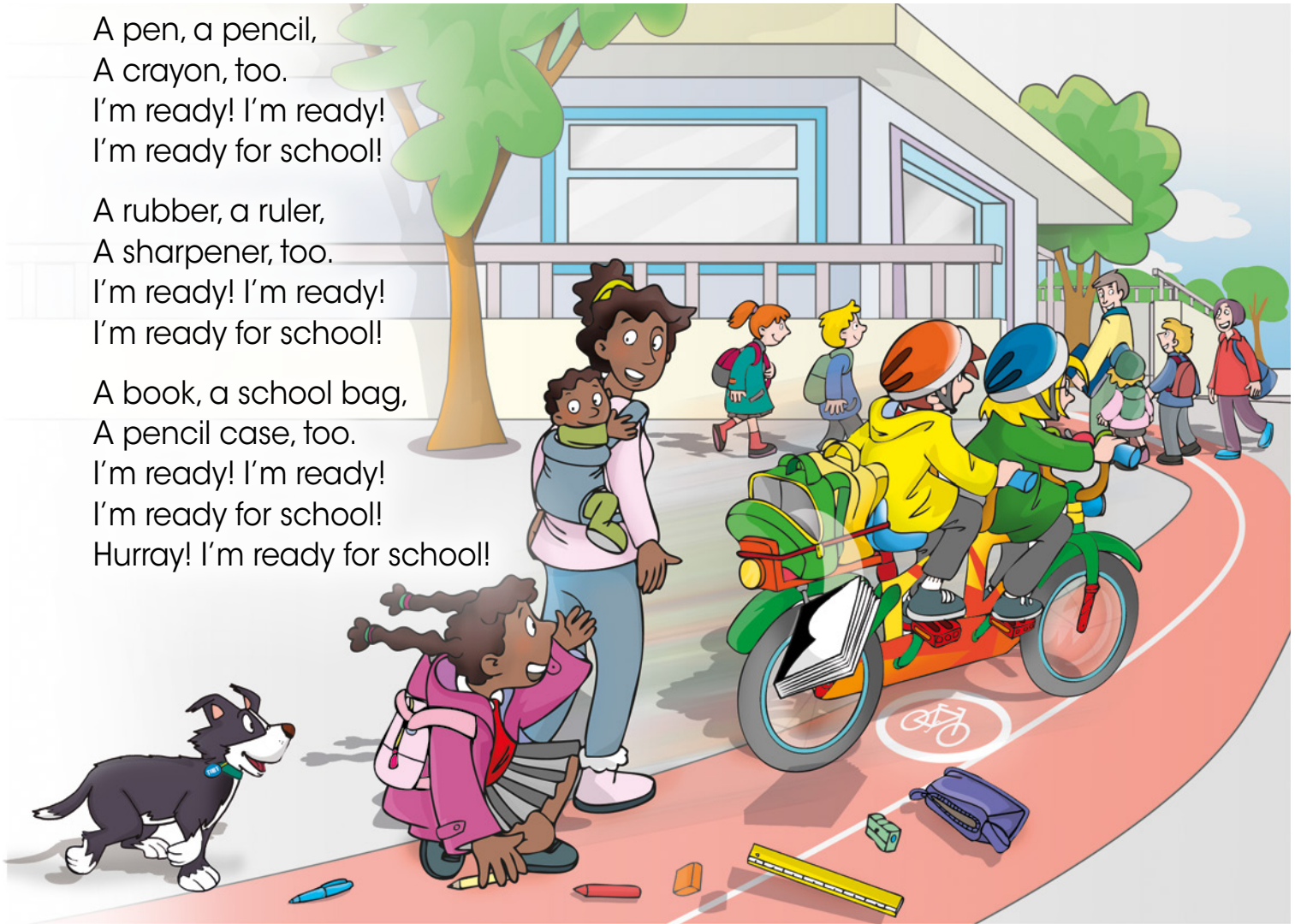

2 Read and stick the ten stickers. Listen and say the chant.



book

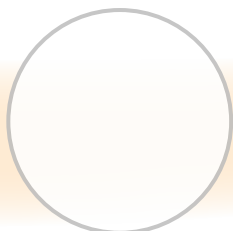

pen

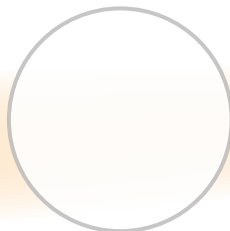

rubber

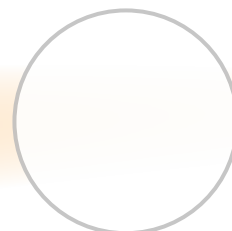

pencil

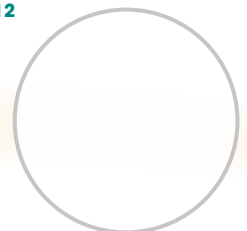

ruler

Learning to learn ➔ Spelling: go to page 15 in your Activity Book.



1 Listen and repeat. Act out.



Grammar

Where's my pencil?
It's here.

2 Listen and find. Circle.

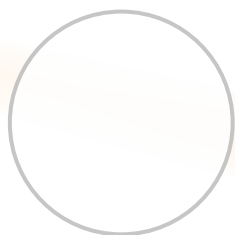

crayon

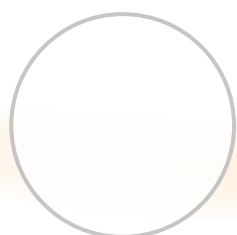

sharpener

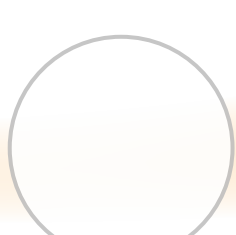

computer

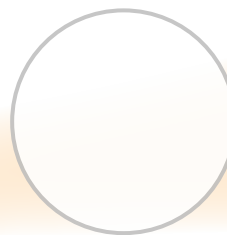

school bag

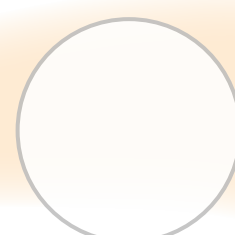

pencil case

Key learning outcomes: use *where's ...?* and *here* to locate objects
Grammar: *Where's my (pen)? It's here.*



Before you read

What classroom objects can you see in the story?

1 Listen and read. Act out.



Toby goes to school



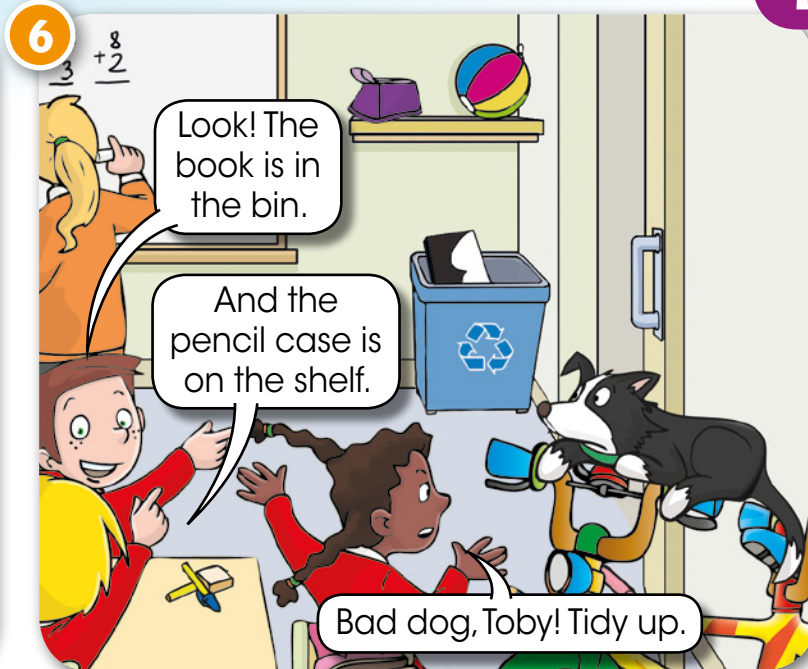

Now watch the animated story!

After you read

➔ Go to page 8 in your Activity Book.

2 **Values** Read and circle.



Keep the classroom tidy.
Put **books** / **crayons** / **rubbish** in the bin.



1 Lesson 4 Vocabulary and Grammar

1 Listen, point and say. CD1 16



shelf



cupboard

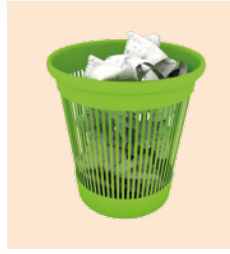

bin



desk



board



chair

2 Listen and point. Sing *Let's tidy up.* CD1 17

Put the book on the shelf,
On the shelf, on the shelf.
Put the book on the shelf.
Let's tidy up!

Put the paper in the bin,
In the bin, in the bin.
Put the paper in the bin.
Let's tidy up!

Put the chair under the desk,
Under the desk, under the desk.
Put the chair under the desk.
Let's tidy up!



3 **Talk Partners** Listen and repeat. Play a game. CD1 18

Put the pencil
under the chair.

Good.



1 Listen and say.  CD1 20

Toby's tongue twister

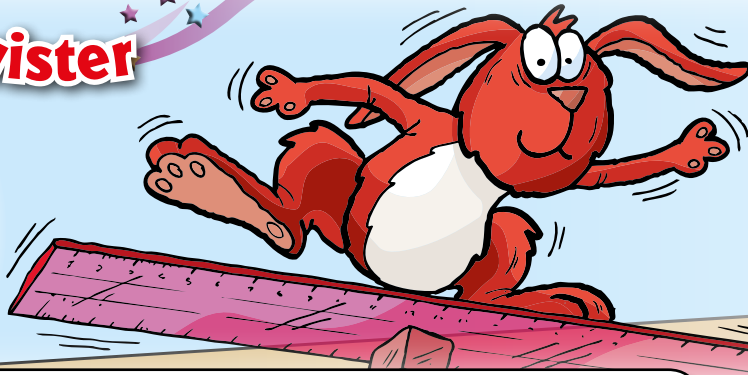

r - r - r. A red rabbit on a red ruler.

2 Listen and match.  CD1 21

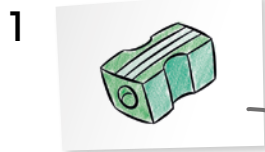

3 **Talk Partners** Make and play the game.

Teacher's Resource Bank: Unit 1

Where's the sharpener?

It's in the cupboard.



1 Listen and read. Answer.



Hello! I'm Alex.

And I'm Lucy. We go to primary school in England. At school, we have an assembly every day.



We sit on the floor with all the children in our school. We listen to the head teacher.

2



We play music and we sing songs.

3



We clap our hands when boys and girls do good work.



Think about your culture

What do you do every day at school?



Text type: **A classroom poster**

Before you read

1 Who are the good children? Circle.



2 Listen and read the classroom poster.



Class rules

Listen to others.

Put your hand up to speak.

Work quietly.

Sit down on your chair.

Walk in the classroom.

Tidy up your things.

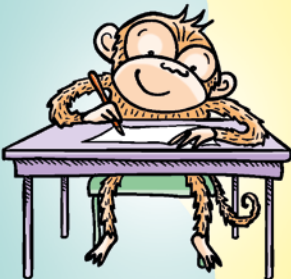

After you read

➔ Go to page 12 in your Activity Book.



1 Listen and number. Write and say.



computer crayon pen rubber pencil ruler
 pencil case ~~sharpener~~ school bag book

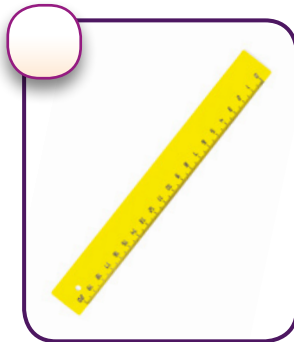

sharpener

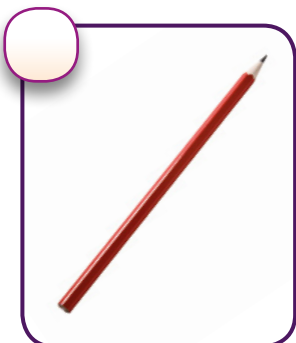

2 Look, read and write *in, on or under*.

- 1 The school bag is under the chair.
- 2 The pencil case is _____ the school bag.
- 3 The ruler is _____ the school bag.
- 4 The rubber is _____ the chair.



3  **Cooperative learning** Sing *Well done!*





Welcome to Channel 21!
This programme is about school. What do you do at school?

1 Watch the video. Number the pictures.



1

2 Watch the video again. Read and tick (✓) or cross (X).

- | | |
|--|---|
| 1 The children read stories. <input checked="" type="checkbox"/> | 3 The children run in the classroom. <input type="checkbox"/> |
| 2 The children sing songs. <input type="checkbox"/> | 4 The children put books in the box. <input type="checkbox"/> |

3 Read and circle.

Being organised



It's important to prepare your school bag.



1 I put my ruler / rubber in my school bag.



2 I put my **book** / pencil case in my school bag.



3 I put my **book** / ball in my school bag.



4 I put my **water** / snack in my school bag.

1 Read and match. Colour and say.

1 a blue book

2 an orange pencil case

3 a brown ruler

4 a green school bag

5 a red computer

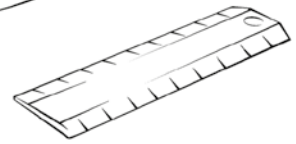
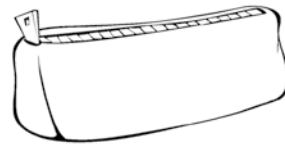

2 Trace and write.

pencil

pen

sharpener

rubber

ruler

~~crayon~~

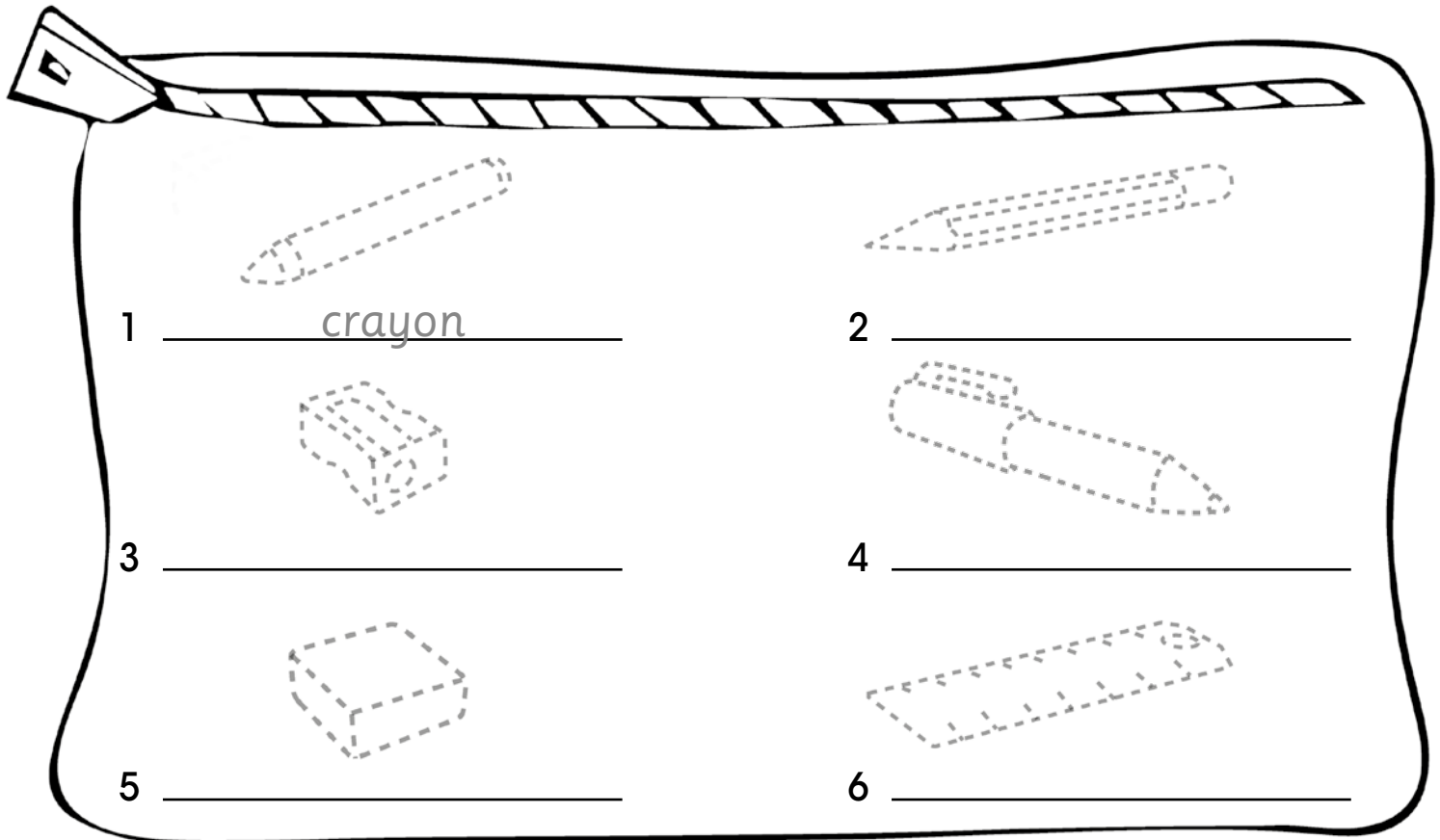

1 _____ crayon _____

2 _____

3 _____

4 _____

5 _____

6 _____





1 Read, follow and draw.

1 Where's my ruler?

2 Where's my sharpener?

3 Where's my book?

4 Where's my crayon?

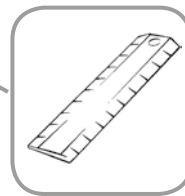

It's here.

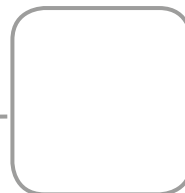

It's here.

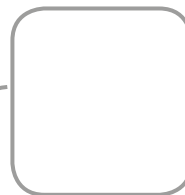

It's here.

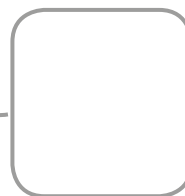

It's here.

2 Talk Partners Choose and write a conversation. Act out.

Oh no! Where's my _____?

It's here.

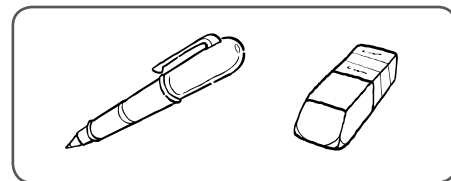

And where's my _____?

It's here, too. Look!

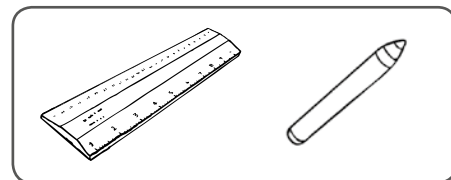

Thank you.

After you read

1 Remember the story. Look and number.

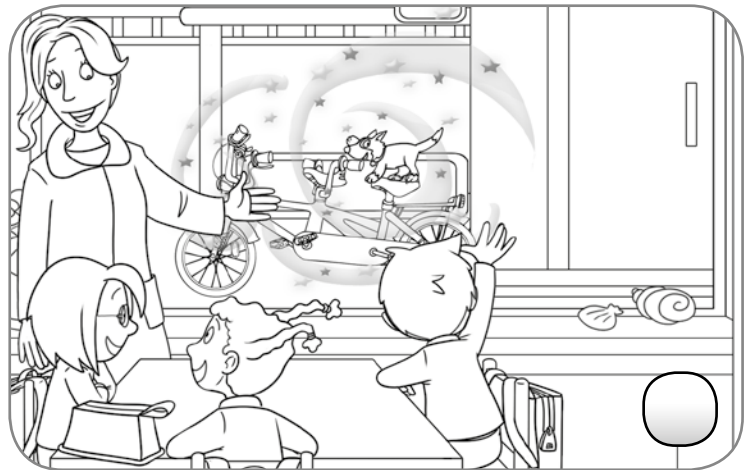
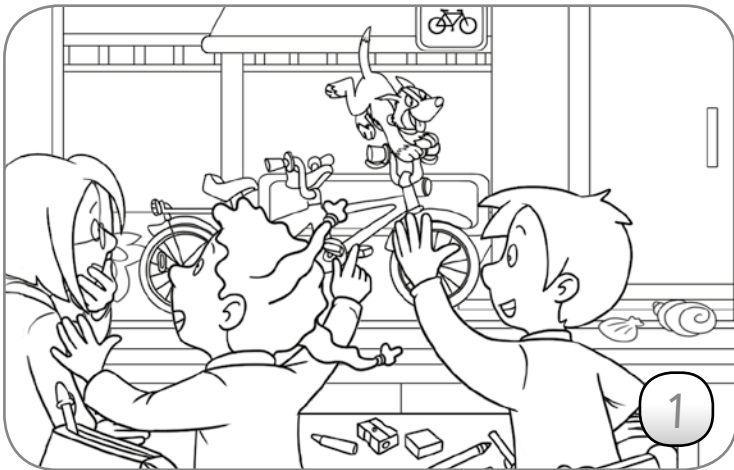
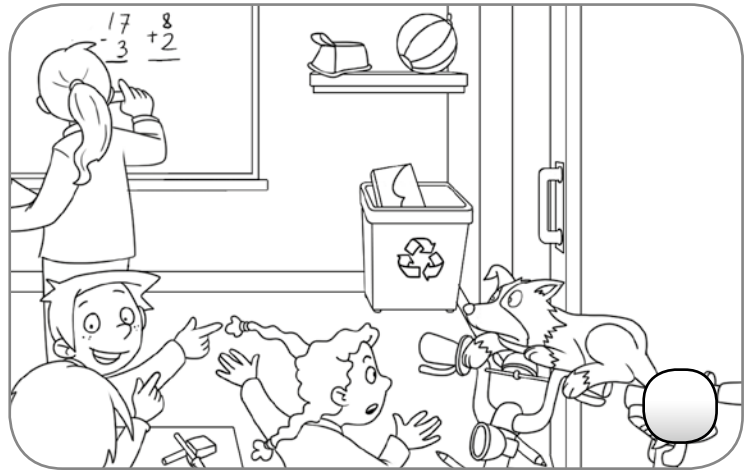

2 Colour the objects in the story. Write.

pink ~~black~~ purple white

1

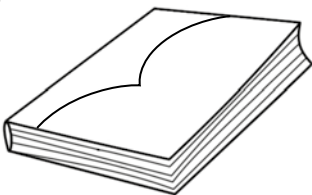

a black and
_____ book

2

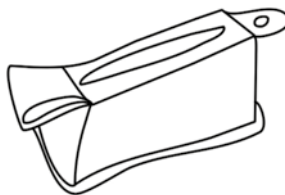

a _____
pencil case

3

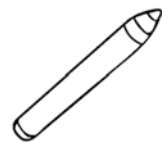

a _____
crayon



1 Listen and tick (✓).  CD1 19

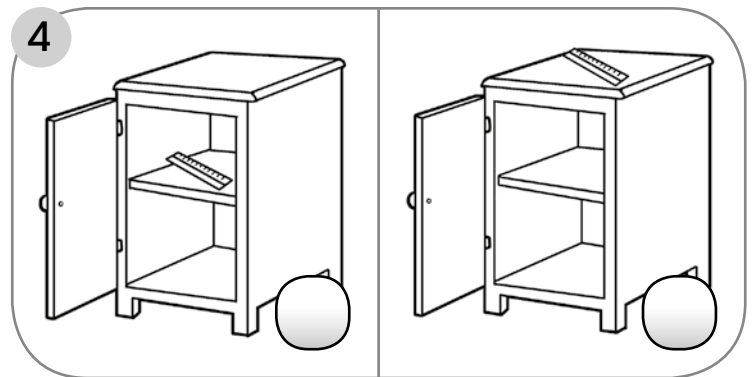
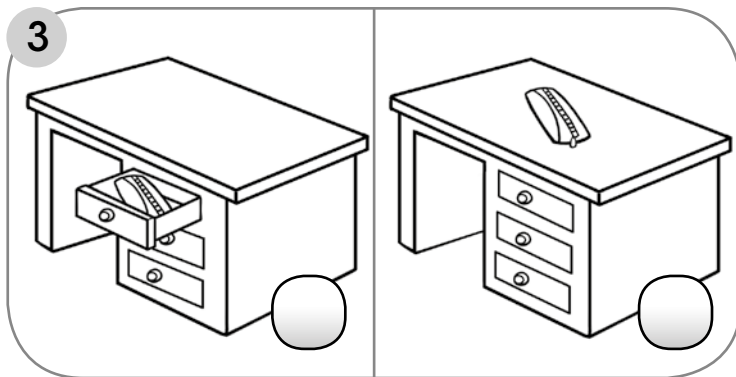
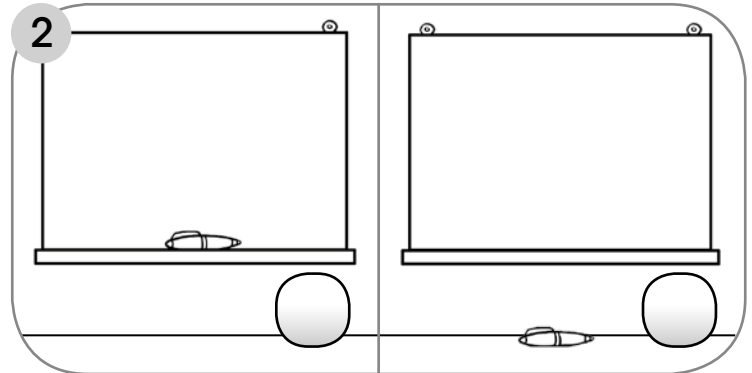
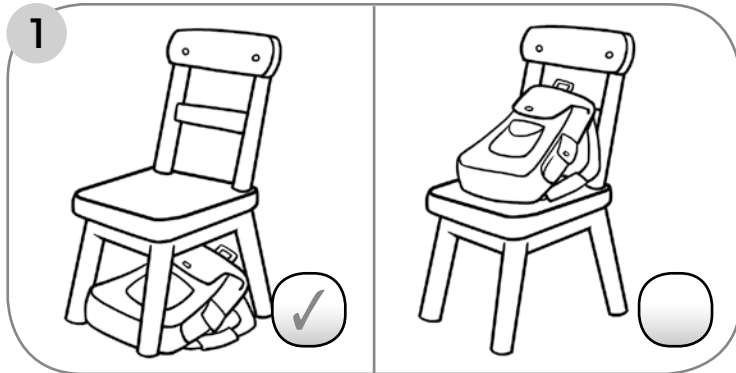

2 Read and draw.

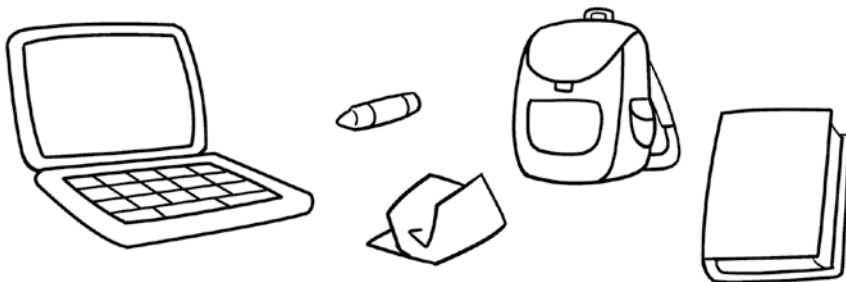

- 1 Put the book on the shelf.
- 2 Put the computer on the desk.
- 3 Put the paper in the bin.
- 4 Put the school bag under the chair.
- 5 Put the crayon in the cupboard.

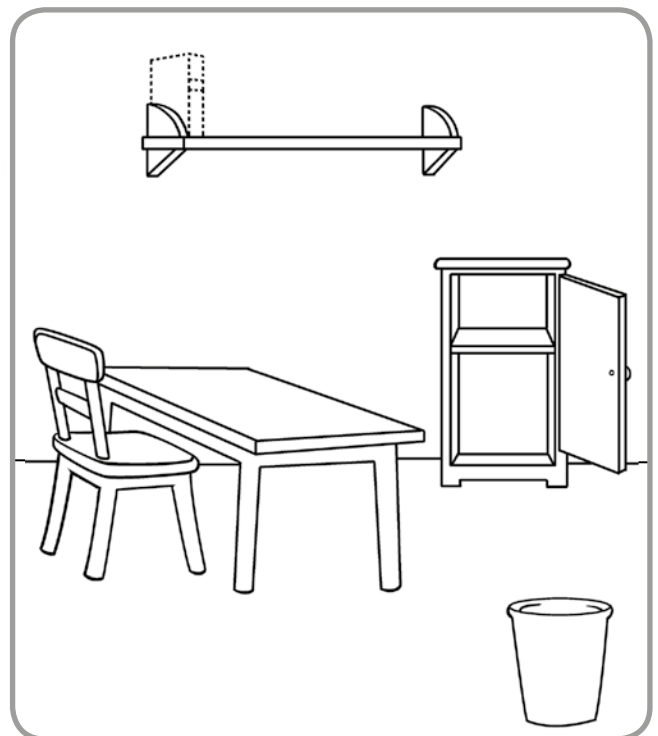

f _____





Toby's tongue twister

1 Write and say.

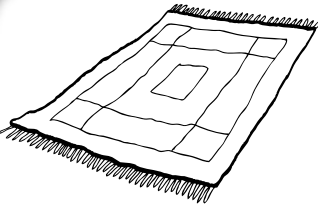
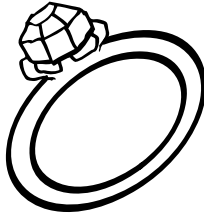
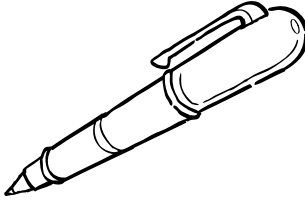

r - r - r. A red abbit on a red ruler.

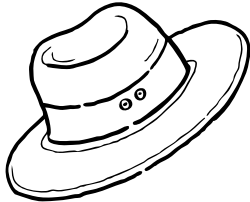
2 Colour the words that begin with 'r'. Say.

			
rug	ring	pen	rabbit
			
rat	hat	read	run

3 **Talk Partners** Play *Fast finger!* in pairs.

Rubber!

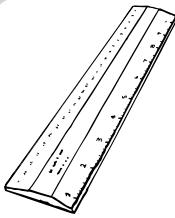

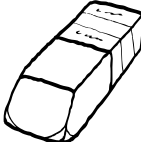



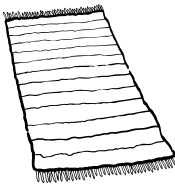













Here!

Play Fast finger! Pupils play with their Talk Partner. Pupil A says a word and Pupil B points to the picture as quickly as possible. They swap roles and repeat. They continue playing until they have found all the words.

10 ten

 9 n_____

1 Listen and number. Say.  CD1 23



We sing songs.



We listen to the head teacher.



We clap our hands.



We play music.

 **Think about your culture**



What do you do at school?

2  Read and tick (✓). Draw and say.

- 1 I listen to the head teacher.
- 2 I play music.
- 3 I sit on the floor.
- 4 I sing songs.

 Text type: **A classroom poster**

After you read

1 Read and number.

- 1 Listen to others.
- 2 Put your hand up to speak.
- 3 Work quietly.
- 4 Sit down on your chair.
- 5 Walk in the classroom.
- 6 Tidy up your things.

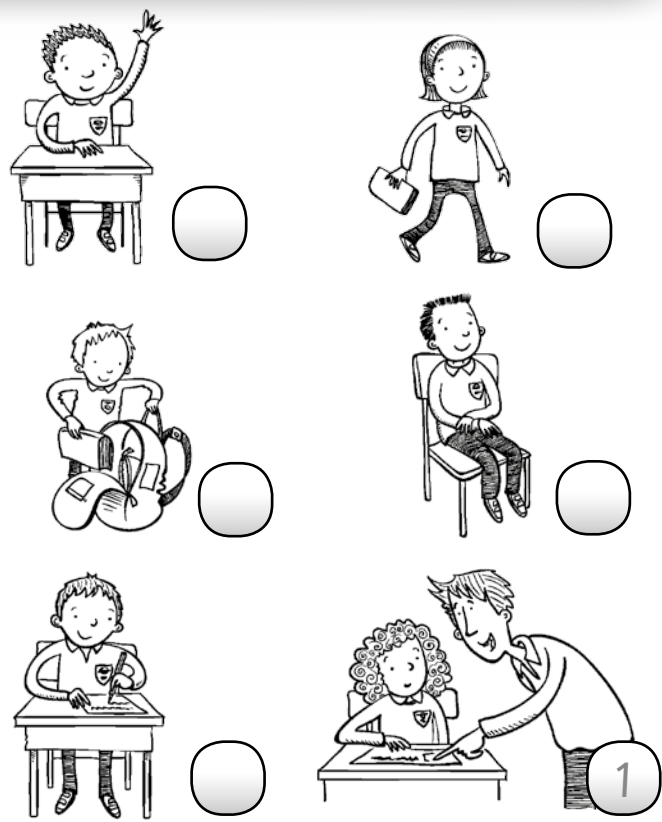

2 Look and colour the good children.

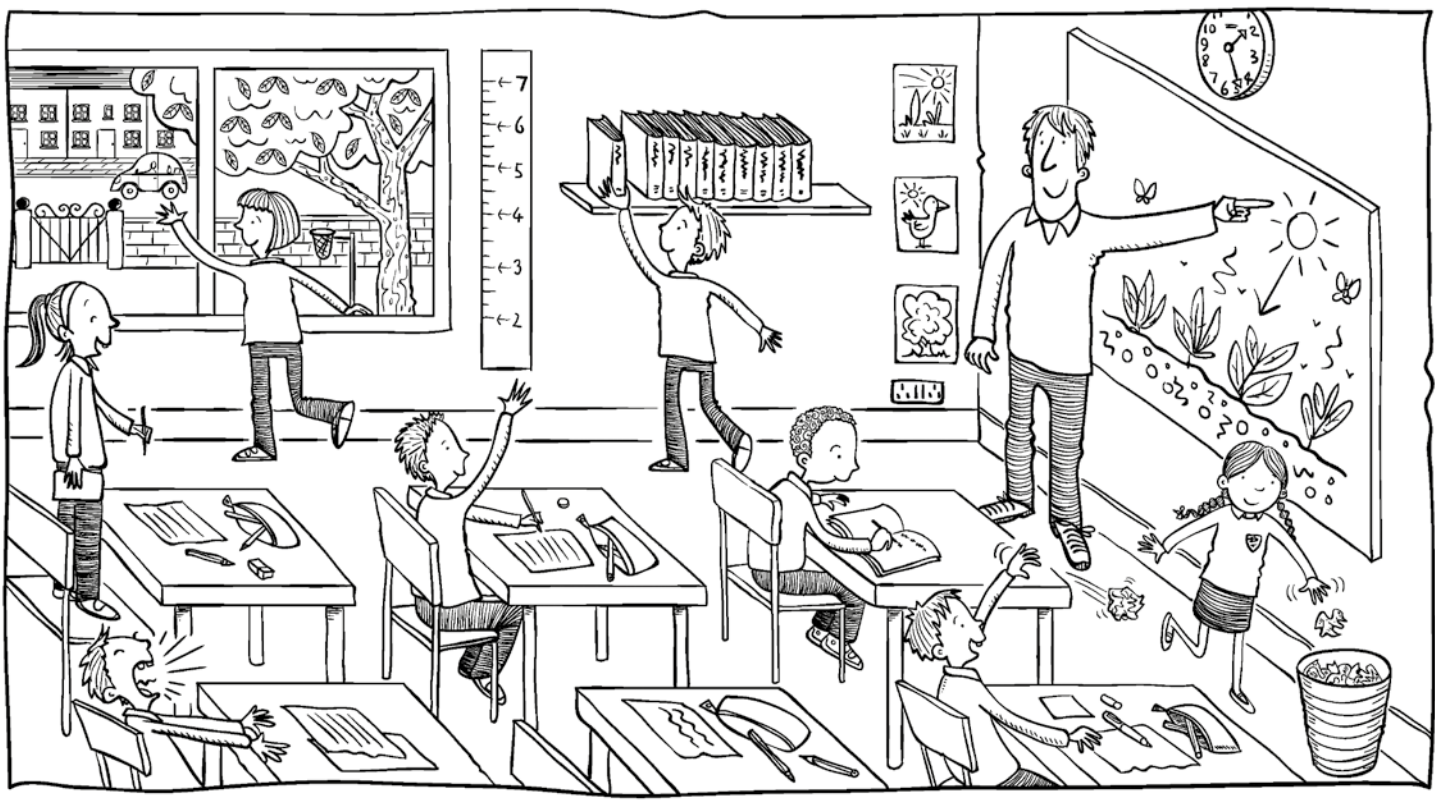

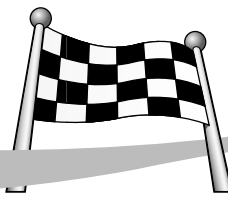

1 What's missing? Look, draw and write.

pen ~~ruler~~ sharpener crayon

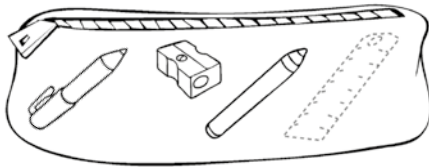

1 Where's my ruler ?

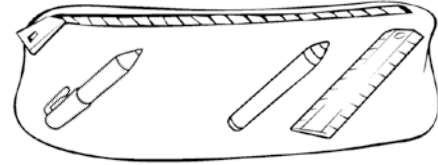

2 Where's my _____ ?

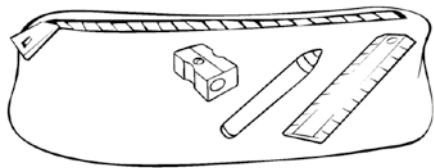

3 Where's my _____ ?

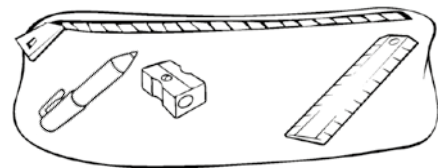

4 Where's my _____ ?

2 Match and write.

shelf ~~pencil~~ desk pencil case school bag computer

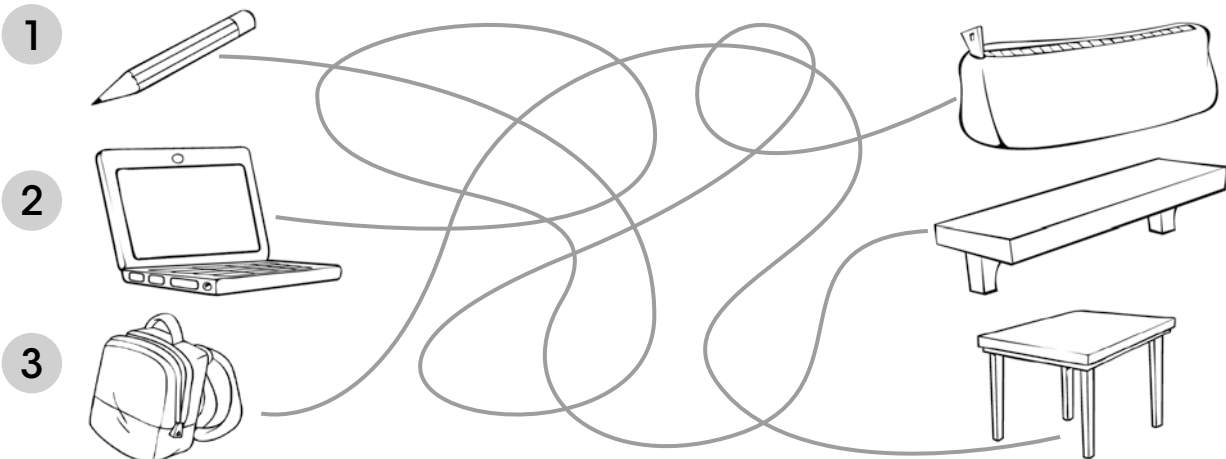

1 Put the pencil in the _____.

2 Put the _____ on the _____.

3 Put the _____ under the _____.

3  **My progress** Use your traffic light. Listen to the teacher and point.

Key for Activity 3: 1. I can say the names of classroom objects. 2. I can ask *Where's my pen?* 3. I listen to the teacher and my friends. 4. I put my hand up to speak. 5. I tidy up my things.

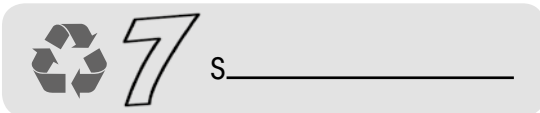



1 What's missing in the school bag? Listen and circle.

1					
2					
3					
4					



What's in your school bag?











2 Read and tick (✓).
Draw, point and say.

- 1 book
- 2 snack
- 3 pencil case
- 4 water
- 5 ruler

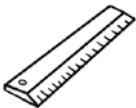



Let's practise spelling!

Look	Copy	Cover and write
1  book	_____	_____
2  pen	_____	_____
3  rubber	_____	_____
4  pencil	_____	_____
5  ruler	_____	_____
6  crayon	_____	_____
7  sharpener	_____	_____
8  computer	_____	_____
9  school bag	_____ _____	_____ _____
10  pencil case	_____ _____	_____ _____



e _____

Unit overview

Key Competences and Key Learning Outcomes



- Identify and say ten classroom objects (Lesson 1)
- Say the vocabulary chant (Lesson 1)
- Use *where's ...?* and *here* in a conversation (Lesson 2)
- Ask and answer the question *Where's my pen?* (Lesson 2)
- Understand and give instructions using prepositions (Lesson 4)
- Watch and understand a video about what children do at school (Video and 21st Century Skills)



- Use the Pupil's App on Navio



- Practise spelling (Lesson 1)
- Say a tongue twister to practise the 'r' sound (Lesson 5)
- Review language in the unit and reflect on own learning (Lesson 8)
- Practise activity types found in the Cambridge English Young Learners Exams: Pre A1 Starters



- Understand the importance of keeping the classroom tidy and putting rubbish in the bin (Lesson 3)
- Read and understand a classroom rules poster (Lesson 7)
- Understand the importance of being organised (Video and 21st Century Skills)



- Work with a Talk Partner to practise and reinforce learning (all lessons)
- Play a communication game about classroom objects (Lesson 5)



- Sing three songs (Lessons 1, 4, and 8)
- Understand and act out a story (Lesson 3)
- Read about school assemblies in Britain (Lesson 6)
- Think about what you do at school (Lesson 6)

Vocabulary

Core vocabulary

book, computer, crayon, pen, pencil, pencil case, rubber, ruler, school bag, sharpener; bin, board, chair, cupboard, desk, shelf

Extension vocabulary (optional)

file, glue, notebook, paintbrush, paper, scissors; bookcase, door, floor, window

Other vocabulary

floor, good work, poster, rules, school assembly, white

Recycled vocabulary

numbers 1–10; colours; days of the week

Structures

Core structures

Where's my (pen)? It's here.

Where's my (purple) (pencil case)?

It's in / on / under the (desk).

The (pencil case) is (on the shelf).

Put the (pencil case) on / in / under (the desk).

Other structures

I'm ready for school. Let's tidy up. We (sit on the floor / listen to the head teacher / sing songs / clap our hands). Listen to others.

Put your hand up to speak. Work quietly. Sit down on your chair.

Walk in the classroom. Tidy up your things. Find the (computer on the desk). Point to the (pencil).

Recycled structures

What's this? It's (a pen). What colour is it? It's (purple).

Phonics

Consonant sound 'r' (red, rabbit, ruler)

British Culture

School assembly



Literacy

Text type: a classroom poster (instructional text)

Reading skill: reading for specific information



21st Century Skills

Ways of working: being organised



Cooperative learning

Song: *Well done!* (Lesson 8)

Skills: **Think-Pair-Share** (Lesson 1); Listening to others (Lesson 2); Developing a positive classroom atmosphere (Lesson 6); Behaving well in class (Lesson 7)

Values

Keeping the classroom tidy

Cross-curricular links

Links to Science

My school: identifying classroom equipment and materials and keeping them tidy; being aware that there are different school subjects; behaving correctly in class and around the school

Suggested Arts and Crafts concepts

Lines and shapes: identifying lines and shapes in Art and around school; using lines and shapes to represent your school

Key Competences and Key Learning Outcomes

- Identify and say ten classroom objects
- Say the vocabulary chant
- Stick the classroom objects stickers
- Practise spelling
- Review classroom objects
- Sing a song about school

Key language

- book, computer, crayon, pen, pencil, pencil case, rubber, ruler, school bag, sharpener
- I'm ready for school.
- Extension: file, glue, notebook, paintbrush, paper, scissors
- Recycled:** eight, five

Materials

- Pupil's Book p8; Activity Book pp6 and 15; Class CD1; Teacher's App on Navio
- Numbers and colours flashcards; classroom objects flashcards; Unit 1 stickers
- Teacher's Resource Bank: Classroom objects word cards
- Teacher's Resource Bank: Task flashcards: listen, sing, read, match, stick, say, colour, write, Talk Partners

Optional materials

- Teacher's Resource Bank: Five Trinity Exam Practice cards (selected from the Starter Unit)

At a Glance Lesson Plan

Starting the lesson

- Use the Trinity Exam Practice cards (optional).
- Review numbers and colours.
- Set learning outcomes using the task flashcards.

Vocabulary presentation

- Present the new vocabulary.

Activity 1

- Listen and point.
- ▶ CD1 Track 10 p256
- Sing I'm ready for school!

Word cards

- Read the word cards.
- Match them to the flashcards.

Activity 2

- Read and stick the ten stickers.
- Listen and say the chant.
- ▶ CD1 Track 12 p256
- Go to the Activity Book.

Pupil's Book

Unit 1 Ready for school! Lesson 1 Vocabulary

1 Listen and point. Sing I'm ready for school!

A pen, a pencil,
A crayon, too,
I'm ready! I'm ready!
I'm ready for school!

A rubber, a ruler,
A sharpener, too,
I'm ready! I'm ready!
I'm ready for school!

A book, a school bag,
A pencil case, too,
I'm ready! I'm ready!
I'm ready for school!
Hurrah! I'm ready for school!

2 Read and stick the ten stickers. Listen and say the chant.

book pen rubber pencil ruler

Learning to learn Spelling: go to page 15 in your Activity Book.

8 eight Key learning outcomes: identify and say ten classroom objects; sing a song about school
Vocabulary: classroom objects

Ending the lesson

- Review the lesson.
- Review the task flashcards.

Extra activity

- Vocabulary Extension**
- Present six additional vocabulary items.

Cooperative learning

- Think-Pair-Share**
- Review classroom objects.

Learning to learn

- Spelling**
- Practise spelling at any time during this unit (Activity Book p15).

Digital resources

Teacher's Digital: Don't forget you can teach this lesson using the Teacher's App on Navio.

Pupil's Digital: Encourage your pupils to use the Pupil's App on Navio to practise the vocabulary from this lesson.



Activity Book

Unit 1 Ready for school! Lesson 1 Vocabulary

1 Read and match. Colour and say.

1 a blue book
2 an orange pencil case
3 a brown ruler
4 a green school bag
5 a red computer

2 Trace and write.

pencil pen sharpener rubber ruler crayon

1 crayon 2 3 4 5 6

6 six

Activity Book

- Activity 1**
- Read and match.
 - Colour and say.

- Activity 2**
- Trace and write.

- Recycled vocabulary**
- Look, remember and write the word.

Spelling

Let's practise spelling!

- Use the Look-Copy-Cover-Write technique.

- Recycled vocabulary**
- Look, remember and write the word.

Detailed Lesson Plan

Starting the lesson

Use the Trinity Exam Practice cards (optional).

- The pupils practise asking and answering questions (see p31).

Review numbers and colours.

- Review numbers and colours using the numbers and colours balloons flashcards.

Set learning outcomes using the task flashcards.

- Say **Today we're going to learn the names of classroom objects.**
- Hold up the task flashcards in turn and elicit the activities. Stick them on one side of the board. Point to them during the lesson to reinforce your instructions.

Vocabulary presentation

Present the new vocabulary.

- (Books closed.) Draw a large school bag on the board.
- Play *Slowly, slowly* to introduce each classroom objects flashcard (see p23). Then stick it inside the school bag.
- Point to each classroom objects flashcard in turn and say the words with the pupils.
- Then play *What's missing?* (see p23).

Pupil's Book Activity 1

Listen and point. Sing *I'm ready for school!*

► CD1 Track 10 p256

- (Books open.) Focus the pupils on Activity 1. Ask **What classroom objects can you see? Who can you see?**
- Play the CD. The pupils listen and point to the objects on the page.
- Play the CD again. The pupils sing and do the actions. Stick the classroom objects flashcards on the board in the order of the song, if necessary.

Word cards

Read the word cards. Match them to the flashcards.

- (Books closed.) Hold up the classroom objects word cards in turn, and say or elicit each word.
- Ask different pupils to come to the front and stick each word card on the board with the corresponding flashcard.
- Point to each word card in turn and elicit the words.

Pupil's Book Activity 2

Read and stick the ten stickers. Listen and say the chant.

► CD1 Track 12 p256

- (Books open.) Ask a pupil to read the first classroom object word. The pupils stick the corresponding sticker. Repeat with the other stickers.
- Play the CD. The pupils listen and say the chant, pointing to the stickers in turn.

Activity Book

Activity 1

Read and match. Colour and say.

- Ask different pupils to read out the phrases. The pupils draw a line to match them to the objects.
- Then they colour the classroom objects and say what each object is.

Activity 2

Trace and write.

- Focus the pupils on Activity 2. Ask different pupils to read out the words from the word box.
- The pupils trace the classroom objects and write the correct words under the pictures.

Answers: 1 crayon 2 pencil 3 sharpener 4 pen 5 rubber 6 ruler

Recycled vocabulary

- The pupils look at the number and write the word. If they can't remember, they look back at the previous unit.

Answer: five

Ending the lesson

Review the lesson.

- (Books closed.) Say **Today we've learnt the names of classroom objects. What classroom objects do you know?** Elicit the classroom objects.

Review the task flashcards.

- Point to the task flashcards. Say **Look at the activities you've done today. Which activity was your favourite?** Elicit the pupils' favourite activities.

Extra activity

Vocabulary Extension

- Use the Vocabulary Booster on Navio to present and practise six additional words to describe classroom objects: *file, glue, notebook, paintbrush, paper, scissors.*



Cooperative learning

Think-Pair-Share

- Ask **Can you remember the ten classroom objects?** The class think silently on their own for one minute.
- **Talk Partners** Then the pupils work with a Talk Partner to name all ten items. Ask a pair to say one of the objects. Praise them for their good memory. Hold up the corresponding flashcard and prompt the class to repeat the word.
- Finally, repeat, asking different pairs of pupils each time, until all ten classroom objects have been named.

Spelling (Activity Book p15)

Let's practise spelling!

- The pupils can practise spelling the ten classroom objects using the *Look-Copy-Cover-Write* technique at any time during this unit before the Lesson 8 Review.

Recycled vocabulary

- The pupils look at the number and write the word. If necessary, they look back at the previous unit.

Answer: eight

Key Competences and Key Learning Outcomes

- Use *where's ...?* and *here* in a conversation
- Ask and answer the question *Where's my (pen)?*
- Listen for specific information

Key language

- *Where's my (pen)? It's here.*
- **Recycled:** book, computer, crayon, pen, pencil, pencil case, rubber, ruler, sharpener, school bag; six

Materials

- Pupil's Book p9; Activity Book p7; Class CD1; Teacher's App on Navio
- Classroom objects flashcards
- Teacher's Resource Bank: Task flashcards: *listen, act out, find, circle, read, follow, draw, write, Talk Partners*

Optional materials

- Teacher's Resource Bank: Five Trinity Exam Practice cards (selected from the Starter Unit)

At a Glance Lesson Plan

Starting the lesson

- Use the Trinity Exam Practice cards (optional).
- Review classroom objects.
- Review the *I'm ready for school!* song.
- ▶ **CD1 Track 10 p256**
- ▶ **CD1 Track 11 p256 (optional karaoke version)**
- Set learning outcomes using the task flashcards.

Activity 1

- Listen and repeat.
- ▶ **CD1 Track 13 p256**
- Act out.

Activity 2

- Listen and find.
- ▶ **CD1 Track 14 p257**
- Circle.

➔ Go to the Activity Book.

Pupil's Book

Ending the lesson

- Review the lesson.
- Review the task flashcards.

Extra activities

Reinforcement

- Practise asking questions.
- **Talk Partners** Play a guessing game.

Cooperative learning

- **Listening to others**
- Play the *Secret message* game.

Digital resources

Teacher's Digital: Don't forget you can teach this lesson using the Teacher's App on Navio.

Pupil's Digital: Encourage your pupils to use the Pupil's App on Navio to practise the vocabulary from this lesson.



Activity Book

Activity Book

Activity 1

- Read, follow and draw.

Activity 2

- Choose and write a conversation.
- **Talk Partners** Act out.

- **Recycled vocabulary**
- Look, remember and write the word.

Detailed Lesson Plan

Starting the lesson

Use the Trinity Exam Practice cards (optional).

- The pupils practise asking and answering questions (see p31).

Review classroom objects.

- Use the classroom objects flashcards to review the vocabulary. Invite a pupil to the front of the class. The pupil holds up one of the flashcards and asks *What's this?* Another pupil answers and says *It's a (book)*. Repeat with different pupils.

Review the *I'm ready for school!* song.

► CD1 Track 10 p256

► CD1 Track 11 p256 (optional karaoke version)

- Invite three pupils to the front of the class and give each one the flashcards that correspond to a verse of *I'm ready for school!* Place a school bag on the desk at the front of the classroom.
- Play the CD (or the karaoke version) and prompt the class to sing. The pupils hold up their flashcards and place them in the school bag when their verse is sung. Repeat with three other pupils.

Set learning outcomes using the task flashcards.

- Say **Today we're going to learn a new question.**
- Hold up the task flashcards in turn and elicit the activities. Stick them on one side of the board. Point to them during the lesson to reinforce your instructions.

Pupil's Book Activity 1



Listen and repeat. Act out.

► CD1 Track 13 p256

- (Books open.) The pupils look at the picture. Ask **What can you see?**
- Play the CD. The pupils listen and read the conversation. Ask **Who has got the pencil? Who has got the book?**
- Play the CD again, pausing after each sentence for the pupils to repeat.
- Ask different pupils to come to the front and act out the conversation.

Pupil's Book Activity 2



Listen and find. Circle.

► CD1 Track 14 p257

- Focus the pupils on Activity 2. Ask **What can you see?** The pupils name the objects on the desk.
- Say **Let's listen.** Play the CD, pausing after each conversation.
- The pupils listen and find the classroom objects. They circle the objects.
- Play the CD again. The pupils listen and point to the object and say *It's here.*

Answers: 1 a rubber 2 a pencil 3 a pen 4 a ruler

Activity Book



Activity 1

Read, follow and draw.

- (Books open.) Read out the first question. The pupils follow the path with their finger. Repeat with the other questions.
- The pupils work on their own. They follow the lines and draw the correct classroom objects.

Answers: ruler, book, sharpener, crayon

Activity 2

Choose and write a conversation.

Talk Partners Act out.

- (Books open.) Read the conversation as a class and complete the speech bubbles with the pupils' ideas.
- Practise the conversation as a class.
- Finally, when the pupils are confident with the language, invite different pairs of pupils to act out their conversations with your help.

Recycled vocabulary

- The pupils look at the number and write the word. If necessary, they look back at the previous unit.

Answer: six

Ending the lesson

Review the lesson.

- (Books closed.) Say **Today we've learnt a new question. What question is it?** Elicit the question and answers from the pupils.

Review the task flashcards.

- Point to the task flashcards. Say **Look at the activities you've done today. Which activity was your favourite?** Elicit the pupils' favourite activities.

Extra activities

Reinforcement

- Put the class into a circle. Give the *ruler* flashcard to one pupil. Ask **What's this?** The pupil answers (*It's a ruler.*) then turns to the pupil on his/her left and asks the same question. That pupil answers, and so on.
- Repeat several times with different classroom objects flashcards.

Talk Partners The pupils play a guessing game with a Talk Partner. Pupil A has his/her eyes closed. Pupil B gives him/her a classroom object and asks *What's this?* Pupil A guesses what it is. The pupils repeat several times, changing roles.



Cooperative learning

Listening to others

- Raise the pupils' awareness of the importance of listening to their classmates by playing the *Secret message* game (Chinese whispers).
- Stick the classroom objects flashcards on the board and organise the class into a line. Whisper the name of a classroom object to the pupil at the end of the line. This pupil whispers the same word to the pupil in front of them. The whispering continues along the line until it arrives at the pupil at the front. This pupil points to the correct flashcard on the board.

Key Competences and Key Learning Outcomes

- Read, listen and understand a story about Toby in school
- Read the story with some fluency
- Become familiar with the story through a pre-reading task
- Understand the importance of keeping the classroom tidy and putting rubbish in the bin
- Understand and act out the story
- Give an opinion on the story

Key language

- *black, pink, purple, white*
- *The (pencil case) is (on the shelf). Put the (pencil case) (on the desk).*
- Recycled:** *one*
- Recycled:** *Where's my (purple) (pencil case)?*

Materials

- Pupil's Book pp10–11; Activity Book p8; Class CD1; Teacher's App on Navio
- Classroom objects flashcards
- Teacher's Resource Bank: Task flashcards: *think, read, listen, act out, circle, number, colour, write*
- Teacher's Resource Bank: Unit 1 Lesson 3 Animated Story
- Crayons or coloured pencils

Optional materials

- Teacher's Resource Bank: Five Trinity Exam Practice cards (selected from the Starter Unit)

At a Glance Lesson Plan

Starting the lesson

- Use the Trinity Exam Practice cards (optional).
- Review the language from Lesson 2.
- Set learning outcomes using the task flashcards.

Before you read

- Explain the story title.
- Read and answer the question.

Activity 1

- Listen and read.
- ▶ **CD1 Track 15 p257**
- Act out.
- ▶ **Now watch the animated story!**

After you read: Activity 2

- ▶ Go to page 8 in your Activity Book.
- Values: Read and circle.

Ending the lesson

- Review the lesson.
- Review the task flashcards.

Pupil's Book

Digital resources

Teacher's Digital: Don't forget you can teach this lesson using the Teacher's App on Navio.

Pupil's Digital: Encourage your pupils to use the Pupil's App on Navio to practise the vocabulary from this lesson.



Activity Book

Activity Book

After you read: Activity 1

- Remember the story. Look and number.

Activity 2

- Colour the objects in the story. Write.

Recycled vocabulary

- Look, remember and write the word.

Detailed Lesson Plan

Starting the lesson

Use the Trinity Exam Practice cards (optional).

- The pupils practise asking and answering questions (see p31).

Review the language from Lesson 2.

- Play *Memory!* (see p23) to review language from Lesson 2.

Set learning outcomes using the task flashcards.

- Say **Today we're going to listen to a story.**
- Hold up the task flashcards in turn and elicit the activities. Stick them on one side of the board. Point to them during the lesson to reinforce your instructions.

Before you read

Explain the story title.

- (Books open.) Focus on the story title. Ask **Do you go to school? Do boys and girls go to school? Do dogs go to school?**

Read and answer the question.

- Read the speech bubble. The pupils scan the story to find the different classroom objects.

Answers: a book, a pencil case, crayons, pencils, rubbers, a sharpener, school bags

Pupil's Book Activity 1

Listen and read. Act out.

► CD1 Track 15 p257

- The pupils place their 'magic finger' on the first frame of the story.
- Play the CD. The pupils point to the different frames as the story progresses. Pause the CD after each frame to check that all the pupils are following.
- Play the CD again. Ask questions about each story frame to help and check understanding.
- Play the CD one more time, pausing it so the pupils can repeat.

Suggested comprehension questions

- Frame 1: **Is Toby happy?** (No.) **Why is he sad?** (*Dogs don't go to school.*)
- Frame 2: **Where is Toby now?** (*On the bike.*)

- Frame 3: **Where is Toby now?** (*In the classroom.*)
- Frame 4: **Is the book on the table?** (No.) **Are the crayons on the table?** (Yes.)
- Frame 5: **Is Molly looking for her book?** (No.) **Is she looking for her purple pencil case?** (Yes.)
- Frame 6: **Where's the black and white book?** (*In the bin.*) **Where's the purple pencil case?** (*On the shelf.*)
- Frame 8: **Where's the purple pencil case now?** (*On the desk.*) **Is the teacher happy?** (Yes.)
- Finally, ask the pupils **Is this a good story?** The pupils give their opinion through gesture (thumbs up / down) or orally (*yes / no*).
- Organise the class into three groups (Beth, Molly and Jake).
- Play the CD. Each group joins in when their character speaks. The groups swap roles and repeat several times.

► **Now watch the animated story**

After you read

- ➔ Go to page 8 in your Activity Book.

Activity Book

After you read: Activity 1

Remember the story. Look and number.

- (Books open.) Ask **Which frame is number 1?**
- The pupils remember the story and answer.
- Then they number the rest of the frames.

Answers: 1 third picture 2 first picture 3 second picture 4 fourth picture

Activity 2

Colour the objects in the story. Write.

- (Books open.) Focus the pupils on Activity 2. Point to each object in turn and ask **What colour is the (book) in the story?**
- The pupils colour the objects and write the colours.

Answers: 1 a black and white book 2 a purple pencil case 3 a pink crayon

Recycled vocabulary

- The pupils look at the number and write the word. If necessary, they look back at the previous unit.

Answer: one

Pupil's Book Activity 2

Values: Read and circle.

- The pupils look at the photo on the right. Read out the first sentence in the speech bubble and prompt the class to tell you which is the correct object to put in the bin.
- Explain the importance of keeping the classroom (and rooms at home) tidy.
- Encourage the pupils to think about how to keep places tidy and what they should put in the bin.

Answer: rubbish

Ending the lesson





Review the lesson.

- (Books closed.) Say **Today we've listened to a story about a dog.** Ask **What happened in the story?** Elicit the story from the pupils.
- Then say **Today you've learnt that we put rubbish in the bin and we keep the classroom tidy.**

Review the task flashcards.



- Point to the task flashcards on the board. Say **Look at the activities you've done today. Which activity was your favourite?** Elicit the pupils' favourite activities.

Key Competences and Key Learning Outcomes

-  Name more classroom objects
-  Use the prepositions *in*, *on* and *under*
-  Give and follow instructions
-  Understand the importance of keeping classroom equipment tidy (optional)
-  Sing a song

Key language

- bin, board, chair, cupboard, desk, shelf*
- Let's tidy up!*
- Put the (paper in the bin).*
- Extension: *bookcase, door, floor, window*

-  **Recycled:** *nine*
-  **Recycled:** *Put the (book) in / on / under the (desk).*

Materials

- Pupil's Book p12; Activity Book p9; Class CD1; Teacher's App on Navio
- Teacher's Resource Bank: Task flashcards: *listen, sing, think, Talk Partners, tick, read, draw*

Optional materials

- Teacher's Resource Bank: Five Trinity Exam Practice cards (selected from the Starter Unit).
- A ruler, a screwed-up piece of paper, a book
- A4 paper, scissors, coloured pencils or crayons

At a Glance Lesson Plan

Starting the lesson

- Use the Trinity Exam Practice cards (optional).
- Review the Lesson 3 story.
- Set learning outcomes using the task flashcards.

Vocabulary presentation

- Present the new vocabulary.



Activity 1

- Listen, point and say.
- ▶ **CD1 Track 16 p257**

Activity 2

- Listen and point.
- Sing *Let's tidy up*.
- ▶ **CD1 Track 17 p257**

Activity 3

- Listen and repeat.
- ▶ **CD1 Track 18 p257**
-  **Talk Partners** Play a game.
-  Go to the Activity Book.

Pupil's Book

1 Lesson 4 Vocabulary and Grammar

1 Listen, point and say.  CD1 14



shelf cupboard bin desk board chair

2 Listen and point. Sing *Let's tidy up*.  CD1 17

Put the book on the shelf.
On the shelf, on the shelf.
Put the book on the shelf.
Let's tidy up!

Put the paper in the bin.
In the bin, in the bin.
Put the paper in the bin.
Let's tidy up!

Put the chair under the desk.
Under the desk, under the desk.
Put the chair under the desk.
Let's tidy up!

3  **Talk Partners** Listen and repeat. Play a game.  CD1 18

Put the pencil under the chair. Good.

12 twelve

Key learning outcomes: give and follow instructions
Vocabulary: classroom objects Grammar: Put the (paper in the bin).

Ending the lesson

- Review the lesson.
- Review the task flashcards.

Extra activity

Vocabulary Extension

- Present four additional vocabulary items.

Link to Science

- My school:** Review classroom equipment and materials and the importance of keeping them tidy.

Digital resources

Teacher's Digital: Don't forget you can teach this lesson using the Teacher's App on Navio.





Pupil's Digital: Encourage your pupils to use the Pupil's App on Navio to practise the vocabulary from this lesson.







Activity Book







Lesson 4 Vocabulary and Grammar **1**

1 Listen and tick (✓).  CD1 19







1   2  

3   4  

2 Read and draw.

- Put the book on the shelf.
- Put the computer on the desk.
- Put the paper in the bin.
- Put the school bag under the chair.
- Put the crayon in the cupboard.

      nine 

Activity Book

Activity 1

- Listen and tick (✓).
- ▶ **CD1 Track 19 p257**

Activity 2

- Read and draw.

Recycled vocabulary

- Look, remember and write the word.

Detailed Lesson Plan

Starting the lesson

Use the Trinity Exam Practice cards (optional).

- The pupils practise asking and answering questions (see p31).

Review the Lesson 3 story.

- Give the pupils two minutes to look at the story. Then say **One, two, three, I can see a (pencil case).** **Where is it?** The pupils scan the story and point to the object. Repeat with other things in the story.

Set learning outcomes using the task flashcards.

- Say **Today we're going to learn some more classroom objects.**
- Hold up the task flashcards in turn and elicit the activities. Stick them on one side of the board. Point to them during the lesson to reinforce your instructions.

Vocabulary presentation

Present the new vocabulary.

- (Books open.) Point to the first photo and read the word. Ask **Is there a shelf in the classroom?** Ask a pupil to find a shelf.
- Repeat with the other photos on Pupil's Book page 12 (Activity 1).

Pupil's Book Activity 1

Listen, point and say.

► CD1 Track 16 p257

- (Books open.) Say **Let's listen and repeat the words.**
- Play the CD. The pupils repeat the words and point to the photos.

Pupil's Book Activity 2

Listen and point. Sing *Let's tidy up.*

► CD1 Track 17 p257

- Use classroom objects to introduce the prepositions 'on', 'in' and 'under'. Say **Put the (ruler) on the chair.** Show a pupil how to do this. Repeat with other actions.
- Place a book and a screwed up piece of paper on the floor, and move a chair away from a desk. Say **Oh dear. Let's tidy up.**
- Play the CD. The class listen and watch you tidy up. Invite three pupils to the front of the class.
- Play the CD again. These pupils do the actions while the rest of the class sing. Repeat.

Pupil's Book Activity 3

Listen and repeat. Play a game.

► CD1 Track 18 p257

- Play the CD. The pupils listen and repeat.
 - The pupils take out their pencils and follow instructions. Say **Put the pencil on the desk. Put the pencil in the desk. Put the pencil under the desk.**
-  **Talk Partners** The pupils practise giving and following instructions with a Talk Partner.

Activity Book

Activity 1

Listen and tick (✓).

► CD1 Track 19 p257

- (Books open.) The pupils say where the school bag is in the first pair of pictures.
- Play the CD, pausing after each conversation. The pupils listen and tick the correct picture.

Answers: 1 under the chair 2 on the board 3 on the desk 4 in the cupboard

Activity 2

Read and draw.

- Focus on the activity. Ask **What can you see?**
- Ask different pupils to read the instructions. Check comprehension.

- The pupils draw the five objects in the correct places in the picture.

Recycled vocabulary

- The pupils look at the number and write the word. If necessary, they look back at the previous unit.

Answer: four

Ending the lesson

Review the lesson.

- (Books closed.) Say **Today we've sung a song. What classroom objects were in the song?** Elicit the classroom objects from the pupils.

Review the task flashcards.

- Point to the task flashcards. Say **Look at the activities you've done today. Which activity was your favourite?** Elicit the pupils' favourite activities.

Extra activity

Vocabulary Extension

- Use the Vocabulary Booster on Navio and present and practise four additional words to describe classroom objects: *bookcase, door, floor, window.*
- Say instructions and the pupils do the actions.
- Play the game *Simon says* with the classroom instructions. Give an instruction to the class. If you say 'Simon says' before the action, the pupils do the action. However, if you don't say 'Simon says' before the action, they do nothing. Say **Simon says 'Stand up!'** The pupils stand up. Say **Sit down!** They remain standing.

Link to Science

- If you are studying the Science topic of **My school** in English, you could review the importance of a tidy classroom and identify classroom equipment and materials.
- Make classroom labels for the different materials and areas of the classroom. The pupils can copy, cut and decorate these classroom labels for you.

Key Competences and Key Learning Outcomes

- Say a tongue twister with the 'r' sound
- Listen for specific information
- Play a communication game about classroom objects

Key language

- *Where's the (sharpener)? It's in / on / under the (desk).*
- Recycled:** bin, board, chair, computer, cupboard, desk, pencil, school bag, sharpener, shelf; four

Materials

- Pupil's Book p13; Activity Book p10; Class CD1; Teacher's App on Navio
- Teacher's Resource Bank: Task flashcards: *listen, say, match, cut out, Talk Partners, write, colour*
- Teacher's Resource Bank: Unit 1 Lesson 5 Activity 3 cut-outs
- Scissors and crayons or coloured pencils

Optional materials

- Teacher's Resource Bank: Five Trinity Exam Practice cards (selected from the Starter Unit)
- Different coloured paper

At a Glance Lesson Plan

Pupil's Book

Starting the lesson

- Use the Trinity Exam Practice cards (optional).
- Review the vocabulary from Lesson 4.
- Set learning outcomes using the task flashcards.

Activity 1

- Listen and say.
- ▶ *CD1 Track 20 p257*
- ➡ Go to Magic Phonics.
- ➡ Go to the Activity Book.

Activity 2

- Listen and match.
- ▶ *CD1 Track 21 p257*

Activity 3

- Make and play the game.
- Talk Partners**

Lesson 5 Speaking 1

1 Listen and say. *Toby's tongue twister*
r - r - r. A red rabbit on a red ruler.

2 Listen and match.

1 2 3 4

3 **Talk Partners** Make and play the game. *Teacher's Resource Bank: Unit 1*

Where's the sharpener?
It's in the cupboard.

Key learning outcomes: play a communication game about classroom objects
Phonics: the 'r' sound
thirteen 13

Ending the lesson

- Review the lesson.
- Review the task flashcards.

Extra activity

Reinforcement

- Make a pronunciation wall display.

Digital resources

Teacher's Digital: Don't forget you can teach this lesson using the Teacher's App on Navio.

Pupil's Digital: Encourage your pupils to use the Pupil's App on Navio to practise the vocabulary from this lesson.



Activity Book

1 Lesson 5 Phonics

1 Write and say. *Toby's tongue twister!*
r - r - r. A red rabbit on a red ruler.

2 Colour the words that begin with 'r'. Say.

rug	ring	pen	rabbit
rat	hat	read	run

3 **Talk Partners** Play *Fast finger!* in pairs.

Rubber!

Here!

ten

Activity Book

Activity 1

- Write and say.

Activity 2

- Colour the words that begin with 'r'. Say.
- ➡ Go to Magic Phonics.

Activity 3

- **Talk Partners** Play *Fast finger!* in pairs.
- Recycled vocabulary**
- Look, remember and write the word.

Detailed Lesson Plan

Starting the lesson

Use the Trinity Exam Practice cards (optional).

- The pupils practise asking and answering questions (see p31).

Review the vocabulary from Lesson 4.

- Ask a pupil to come to the front of the class. Say **You are a robot. Put the (crayon) on the (desk).** The pupils moves like a robot and does the actions.
- Repeat with different pupils and the prepositions 'in' and 'under'.

Set learning outcomes using the task flashcards.

- Say **Today we're going to practise saying a tongue twister and make and play a speaking game.**
- Hold up the task flashcards in turn and elicit the activities. Stick them on one side of the board. Point to them during the lesson to reinforce your instructions.

Pupil's Book Activity 1

Listen and say.

► CD1 Track 20 p257

- (Books open.) Write the target 'r' sound on the board and say it. The pupils repeat.
- Say **It's time for Toby's tongue twister. What can you see here? Can you see a rabbit? What colour is the ruler?**
- Play the CD. The pupils listen and repeat the target sound, then the words and then the entire tongue twister, faster and faster.

➡ Go to Magic Phonics.

Activity Book

Activity 1

Write and say.

- (Books open.) The pupils write the letter 'r' in the tongue twister.
- The pupils say the tongue twister.

Answer: A red rabbit on a red ruler.

Activity 2

Colour the words that begin with 'r'. Say.

- Ask the pupils to colour the words that begin with 'r'.
- The pupils say the words.

Answers: rug, ring, rabbit, rat, read, run

➡ Go to Magic Phonics.

Activity 3

Play *Fast finger!* in pairs.

- Demonstrate the activity. Say a word and the pupils point to the picture representing the object as quickly as possible. Repeat with several words.

 **Talk Partners** The pupils take turns to play the game with a Talk Partner. One pupil says a word and the other needs to point to the picture representing that object as quickly as possible. They continue playing until they've found all the words in the game.

Recycled vocabulary

- The pupils look at the number and write the word. If necessary, they look back at the previous unit.

Answer: nine

Pupil's Book Activity 2

Listen and match.

► CD1 Track 21 p257

- Focus the pupils on Activity 2. Ask **What can you see?**
- Play the CD, pausing after the first conversation so the pupils can match the classroom objects to the main picture.

- Play the rest of the CD. The pupils listen and match.

Answers: 1 in the cupboard 2 on the shelf
3 under the chair 4 under the desk

Pupil's Book Activity 3

Make and play the game.

- Focus the pupils on Activity 3. Tell the class that they are going to play the game.
- The pupils cut out and colour the cards and place them on their desk.
- Demonstrate the activity. A volunteer asks *Where's the (pencil)?* Answer the question **It's (on the desk).** The pupils put the (pencil on the desk).
- Ask a pupil to take your part. The rest of the class asks him / her questions.

 **Talk Partners** The pupils play the game with a Talk Partner.

Ending the lesson

Review the lesson.

- (Books closed.) Say **Today we've practised a tongue twister.** Elicit the tongue twister from the pupils.

Review the task flashcards.

- Point to the task flashcards. Say **Look at the activities you've done today. Which activity was your favourite?** Elicit the pupils' favourite activities.

Extra activity

Reinforcement

- Make a pronunciation wall display. Cut out the letter 'r' in coloured paper. Stick it onto a piece of differently coloured paper to make a wall display. Elicit words that begin with that letter and write them on the wall display.
- Encourage the pupils to add new words beginning with the letter 'r' during the year.

Key Competences and Key Learning Outcomes



• Review school subjects (optional)



• Listen for general information



• Read about school assemblies in Britain
• Think about what you do at school

Key language

- *We sit on the floor. We listen to the head teacher. We play music. We sing songs. We clap our hands.*
- *floor, good work, school, assembly*

Recycled: *two*

Materials

- Pupil's Book p14; Activity Book p11; Class CD1; Teacher's App on Navio
- Teacher's Resource Bank: Task flashcards: *listen, read, think, number, tick, draw*

Optional materials

- Teacher's Resource Bank: Five Trinity Exam Practice cards (selected from the Starter Unit)
- A camera, pieces of A4 paper

At a Glance Lesson Plan

Starting the lesson

- Use the Trinity Exam Practice cards (optional).
- **Talk Partners** Review Toby's tongue twister.
- ▶ **CD1 Track 20 p257**
- Set learning outcomes using the task flashcards.

Activity 1

- Listen and read.
- ▶ **CD1 Track 22 p257**
- Answer.

Think about your culture

- What do you do every day at school?
- ➔ Go to the Activity Book.

Pupil's Book

Lesson 6 **British culture**

1 Listen and read. Answer.

Hello! I'm Alex.

And I'm Lucy. We go to primary school in England. At school, we have an assembly every day.

2 We sit on the floor with all the children in our school. We listen to the head teacher.

3 We play music and we sing songs.

We clap our hands when boys and girls do good work.

Think about your culture
What do you do every day at school?

14 fourteen

Key learning outcomes: read about school assemblies in Britain; think about what you do at school

Ending the lesson

- Review the lesson.
- Review the task flashcards.

Extra activities

Reinforcement

- Play an assembly game.

Extension

- Make a class wall display.

Cooperative learning

Developing a positive classroom atmosphere

- Set up an assembly in the classroom.

Link to Science

- **School subjects:** Review school subjects.

Activity Book

Lesson 6 **British culture**

1 Listen and number. Say.

We sing songs.

We listen to the head teacher.

We clap our hands.

We play music.

Think about your culture
What do you do at school?

2 Read and tick (✓). Draw and say.

1 I listen to the head teacher.

2 I play music.

3 I sit on the floor.

4 I sing songs.

21 eleven

Activity Book

Activity 1

- Listen and number.
- ▶ **CD1 Track 23 p257**
- Say.

Activity 2: Think about your culture

- Read and tick (✓).
- Draw and say.

Recycled vocabulary

- Look, remember and write the word.

Digital resources

Teacher's Digital: Don't forget you can teach this lesson using the Teacher's App on Navio.



Detailed Lesson Plan

Starting the lesson

Use the Trinity Exam Practice cards (optional).

- The pupils practise asking and answering questions (see p31).

Review Toby's tongue twister.

► CD1 Track 20 p257

- Ask **What sound did you practise in Toby's tongue twister? Can you remember the tongue twister?** (*A red rabbit on a red ruler.*)

- Play the CD. Practise the tongue twister as a class.

 **Talk Partners** The pupils practise saying the tongue twister as fast as possible with a Talk Partner. Choose a fast pair to say it for the class.

Set learning outcomes using the task flashcards.

- Say **Today we're going to learn about assemblies in Britain.**
- Hold up the task flashcards in turn and elicit the activities. Stick them on one side of the board. Point to them during the lesson to reinforce your instructions.

Pupil's Book Activity 1

Listen and read. Answer.

► CD1 Track 22 p257

- (Books open.) Focus attention on the photos at the top of the page and ask **What can you see?** (*A boy and girl.*) Say **Their names are Alex and Lucy. They are ready for school.** Focus the class on the other photos and ask **What can you see?** Then say **Let's read and listen.**
- Play the CD. Pause the CD after the first piece of information. Ask **Do Alex and Lucy sit on a chair in assembly? (No.) Do they sit on the floor? (Yes.)** Highlight that the whole school sits on the floor in assembly every morning. Repeat with the other photos, pausing to check comprehension each time.
- Ask the pupils to mime the actions to show they understand.

Pupil's Book Think about your culture

What do you do every day at school?

- Read out the question. The pupils answer.
- Ask questions, e.g. **Do you have an assembly every day? Do you (sing songs / sit on the floor / play music)? Do you listen to the head teacher?**

Activity Book

Activity 1

Listen and number. Say.

► CD1 Track 23 p257

- (Books open.) Tell the pupils they are going to listen to a teacher and some children in an assembly at school.
- Play the CD, pausing after the first section. Ask **What do the children do?** The pupils point to the correct box.
- Repeat with all four sections of the audio. The pupils write the numbers in the correct boxes.

Answers: 1 We listen to the head teacher. 2 We clap our hands. 3 We sing songs. 4 We play music.

Activity 2: Think about your culture

Read and tick (✓). Draw and say.

- Read out the question in the speech bubble. Elicit the pupils' answers.
- Read the four sentences. The pupils tick the things they do at school.
- The pupils draw themselves doing one of the actions.
- Invite different pupils to show the class their drawings and say what they do.

Recycled vocabulary

- The pupils look at the number and write the word. If necessary, they look back at the previous unit.

Answer: two

Ending the lesson

Review the lesson.

- (Books closed.) Say **Today we've talked about what you do at school. What do you remember?** Elicit the activities from the pupils.

Review the task flashcards.

- Point to the task flashcards. Say **Look at the activities you've done today. Which activity was your favourite?** Elicit the pupils' favourite activities.

Extra activities

Reinforcement

- Say **Let's play an assembly game.** Say **Sit on the floor.** Prompt the children to do the action. Repeat the procedure with the other actions: **Listen to a story. Sing a song. Play music. Think. Clap your hands.** Repeat the instructions in a random order. The pupils listen and do the action each time.

Extension

- Work together as a class to make a display of what the pupils do at school. Take photos of the pupils doing daily tasks and stick them on a piece of paper. The pupils copy sentences from the board and write them below their photo: *I sing songs. I write. I speak English.* Display the photos.



Cooperative learning

Developing a positive classroom atmosphere

- Set up an assembly in the classroom to develop a positive classroom atmosphere. Decide what activities to do in the assembly such as reading a book, singing a song or playing music.
- The pupils sit on the floor in a circle. Ask the pupils to perform the activities.
- Praise good behaviour. Remind the pupils that they should listen when somebody is speaking.

Link to Science

- If you are studying the Science topic of **My school** in English, you could review the different subjects (Music, Science, Art and PE) and activities (read, write, draw, sing, think, speak English) that they do at school.

Key Competences and Key Learning Outcomes

- Review how to line up correctly (optional)
- Read and understand a classroom rules poster
- Think about good behaviour in the classroom and class rules

Key language

- *poster, rules*
- *Listen to others. Put your hand up to speak. Work quietly. Sit down on your chair. Walk in the classroom. Tidy up your things.*
- ♻️ **Recycled:** *ten*

Materials

- Pupil's Book p15; Activity Book p12; Class CD1; Teacher's App on Navio
- Teacher's Resource Bank: Task flashcards: *think, circle, listen, read, number, colour*

Optional materials

- Teacher's Resource Bank: Five Trinity Exam Practice cards (selected from the Starter Unit)

At a Glance Lesson Plan

Starting the lesson

- Use the Trinity Exam Practice cards (optional).
- Review the culture lesson.
- Set learning outcomes using the task flashcards.

Before you read

- Talk about good behaviour.

Activity 1

- Who are the good children?
- Circle.

Activity 2

- Listen and read the classroom poster.
- ▶ **CD1 Track 24 p257**

After you read

- ◀ Go to page 12 in your Activity Book.

Pupil's Book

Text type: A classroom poster Lesson 7 Literacy 1

Before you read!

1 Who are the good children? Circle.



2 Listen and read the classroom poster.

Class rules

Listen to others.

Put your hand up to speak.

Work quietly.

Sit down on your chair.

Walk in the classroom.

Tidy up your things.

After you read!

Go to page 12 in your Activity Book.

Key learning outcomes: read and understand a classroom rules poster fifteen 15

Ending the lesson

- Review the lesson.
- Review the task flashcards.

Extra activities

- Extension**
- Decide on the most important class rule.
 - Make a classroom poster.

Cooperative learning

- Behaving well in class**
- Talk about rules.

Link to Science

- **My school:** Review how to line up correctly.

Digital resources

Teacher's Digital: Don't forget you can teach this lesson using the Teacher's App on Navio.

Pupil's Digital: Encourage your pupils to use the Pupil's App on Navio to practise the vocabulary from this lesson.



Activity Book

Lesson 7 Literacy

Text type: A classroom poster

After you read!

1 Read and number.

- 1 Listen to others.
- 2 Put your hand up to speak.
- 3 Work quietly.
- 4 Sit down on your chair.
- 5 Walk in the classroom.
- 6 Tidy up your things.

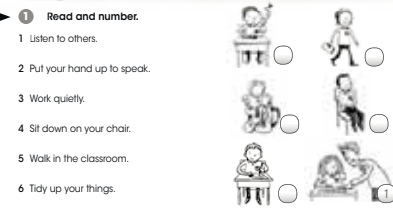

2 Look and colour the good children.



twelve 12

10

Activity Book

After you read: Activity 1

- Read and number.

Activity 2

- Look and colour the good children.

Recycled vocabulary

- Look, remember and write the word.

Detailed Lesson Plan

Starting the lesson

Use the Trinity Exam Practice cards (optional).

- The pupils practise asking and answering questions (see p31).

Review the culture lesson.

- Review the actions that British children do in an assembly. Use mime to elicit the different activities. (*Listen to the head teacher. Sing songs. Play music. Clap our hands.*)
- Repeat the instructions. The pupils listen and do the actions.

Set learning outcomes using the task flashcards.

- Say **Today we're going to read a classroom poster.**
- Hold up the task flashcards in turn and elicit the activities. Stick them on one side of the board. Point to them during the lesson to reinforce your instructions.

Before you read

Talk about good behaviour.

- Ask the children to give examples of good behaviour (being polite, listening to others, following rules, etc.).

Pupil's Book Activity 1

Who are the good children? Circle.

- (Books open.) Point to an illustration and say **Look at the boys and girls. Where are they?** (*In the classroom.*) Point to the first picture and ask **Is this good (behaviour) or bad (behaviour) in the classroom?** (*Good.*) Say **Yes, it's good. Is the teacher happy with this (boy)?** (*Yes.*) Repeat with the other illustrations, prompting the pupils to say 'good' or 'bad' each time.
- The pupils circle the good children.

Answers: first, third and sixth pictures

Pupil's Book Activity 2

Listen and read the classroom poster.

► CD1 Track 24 p257

- Focus the class on the poster and say **Here are the class rules.** Explain that the rules tell the pupils what is good (behaviour) in the class. Ask **How many rules are on the poster?** (*Six.*)
- Play the CD. The pupils listen and read.
- Play the CD again, pausing after each class rule. The pupils point to the corresponding illustrations.
- Ask different pupils to read the rules. Encourage the pupils to do the actions.

Activity Book

After you read: Activity 1

Read and number.

- (Books open.) Read the first classroom rule. Ask **What's the picture?**
- Repeat with all the rules.
- The pupils read and write the numbers.

Answers: 1 sixth picture 2 first picture 3 fifth picture
4 fourth picture 5 second picture 6 third picture

Activity 2

Look and colour the good children.

- Focus the pupils on Activity 2. The pupils look and colour the six good children.
- Circulate, helping where necessary.

Answers: Boy with hand up / Boy working quietly / Boy sitting on his chair / Boy listening to the teacher / Girl putting rubbish in the bin / Boy putting a book on the shelf

Recycled vocabulary

- The pupils look at the number and write the word. If necessary, they look back at the previous unit.

Answer: ten

Ending the lesson

Review the lesson.

- (Books closed.) Say **Today we've read a classroom poster in English. What did it say?** Elicit the class rules from the pupils.

Review the task flashcards.

- Point to the task flashcards. Say **Look at the activities you've done today. Which activity was your favourite?** Elicit the pupils' favourite activities.

Extra activities

Extension

- The pupils decide which class rule is the most important. They write it in their notebooks.
- Write the most important classroom rule on the board.
- The pupils make a classroom poster of good behaviour.



Cooperative learning

Behaving well in class

- Ask the pupils if class rules are a good idea. Explain that rules are important for children to work together and learn.

Link to Science



- If you are studying the Science topic of **My school** in English, you could review how to line up correctly.
- Practise lining up quickly and quietly with the class. Repeat the language that they know (*Line up. One behind the other. Hands down. Mouth closed. Don't push.*) Ask five different pupils to line up each time and at the end of the activity decide which group lined up the best.

Key Competences and Key Learning Outcomes



- Review language in the unit
- Reflect on own learning



- Sing a cooperative learning song

Key language

Recycled: book, computer, crayon, pen, pencil, pencil case, rubber, ruler, sharpener, school bag; bin, board, chair, cupboard, desk, shelf; three

Recycled: Where's my (book)? The (rubber) is in / on / under the (chair).

Materials

- Pupil's Book p16; Activity Book p13; Class CD1; Teacher's App on Navio
- Classroom objects flashcards
- Teacher's Resource Bank: Task flashcards: *listen, number, write, read, sing, stick, draw, match, think*
- Teacher's Resource Bank: Traffic light cut-out
- Give Me Five! sticker

Optional materials

- Teacher's Resource Bank: Five Trinity Exam Practice cards (selected from the Starter Unit)

At a Glance Lesson Plan

Starting the lesson

- Use the Trinity Exam Practice cards (optional).
- Review the unit vocabulary.
- Set learning outcomes using the task flashcards.

Activity 1

- Listen and number.
- ▶ CD1 Track 25 p258
- Write and say.

Activity 2

- Look, read and write *in, on or under*.

Activity 3

Cooperative learning

- Sing *Well done!*
- ▶ CD1 Track 26 p258
- Stick the *Give Me Five!* sticker.
- ➔ Go to the Activity Book.

Pupil's Book

1 Lesson 8 Review

1 Listen and number. Write and say.

computer crayon pen rubber pencil ruler
pencil case sharpener school bag book

sharpener

2 Look, read and write *in, on or under*.

1 The school bag is under the chair.
2 The pencil case is _____ the school bag.
3 The ruler is _____ the school bag.
4 The rubber is _____ the chair.

3 **Cooperative learning** Sing *Well done!*

16 sixteen Key learning outcomes: review language in the unit
Language: classroom objects and prepositions of place

Ending the lesson

- Review the task flashcards.

Activity Book

Lesson 8 Review 1

1 What's missing? Look, draw and write.

pen ruler sharpener crayon

1 Where's my ruler? 2 Where's my _____?

3 Where's my _____? 4 Where's my _____?

2 Match and write.

shelf pencil desk pencil case school bag computer

1
2
3

1 Put the pencil in the _____
2 Put the _____ on the _____
3 Put the _____ under the _____

3 **My progress** Use your traffic light. Listen to the teacher and point.

13 thirteen

Activity Book

Activity 1

- What's missing?
- Look, draw and write.

Activity 2

- Match and write.

Activity 3

- Use your traffic light. Listen to the teacher and point.

Recycled vocabulary

- Look, remember and write the word.

Digital resources

Teacher's Digital: Don't forget you can teach this lesson using the Teacher's App on Navio.

Pupil's Digital: Encourage your pupils to use the Pupil's App on Navio to practise the vocabulary from this lesson.



Detailed Lesson Plan

Starting the lesson

Use the Trinity Exam Practice cards (optional).

- The pupils practise asking and answering questions (see p31).

Review the unit vocabulary.

- Hold up a classroom objects flashcard and elicit the word. Stick the flashcards face down on the board. Repeat until all the flashcards are on the board.
- Ask **Where's the (ruler)?** Ask a pupil to turn over one of the flashcards. If it's the correct flashcard, he/she says *It's here*. If it isn't the correct flashcard, another pupil has a go. Repeat with different words.
- Variation: Play the game in two teams. The teams take it in turns to remember the classroom objects.

Set learning outcomes using the task flashcards.

- Say **Today we're going to remember what we've learnt in Unit 1.**
- Hold up the task flashcards in turn and elicit the activities. Stick them on one side of the board. Point to them during the lesson to reinforce your instructions.

Pupil's Book Activity 1

Listen and number. Write and say.

► CD1 Track 25 p258

- (Books open.) Ask different pupils to name the classroom objects.
- Play the CD, pausing it after each conversation. The pupils point to the object.
- Play the CD again. The pupils number the objects.
- The pupils write the names of the objects on their own and say the words.

Answers: 1 sharpener 2 book 3 pencil 4 rubber 5 pen 6 ruler 7 school bag 8 pencil case 9 crayon 10 computer

Pupil's Book Activity 2

Look, read and write *in, on or under*.

- Focus the pupils on the picture in Activity 2. Ask **What can you see? Where's the rubber?**
- Read out the sentences and elicit the missing words.
- The pupils write the correct prepositions.

Answers: 1 under 2 in 3 under 4 on



Pupil's Book Activity 3: Cooperative learning

Sing *Well done!*

► CD1 Track 26 p258

- Praise the pupils for their hard work and play the *Well done!* song. The pupils sing and do the actions.

Stick the *Give Me Five!* sticker.

- The pupils stick the *Give Me Five!* sticker on the Pupil's Book page.
- Variation: Sing the *Well done!* song and stick the *Give Me Five!* sticker after the pupils have also completed the Activity Book Lesson 8 Review.

Activity Book

Activity 1

What's missing? Look, draw and write.

- (Books open.) Elicit what's missing from each pencil case.
- The pupils draw the objects and write the words.

Answers: 1 ruler 2 sharpener 3 pen 4 crayon

Activity 2

Match and write.

- Focus the pupils on Activity 2. Ask **Where do I put the pencil?**
- The pupils follow the lines to match the objects. Then they complete the sentences.

Answers: 1 pencil / pencil case 2 computer / shelf 3 school bag / desk

Activity 3: My progress



Use your traffic light. Listen to the teacher and point.

- (Books closed.) Ask the pupils to take out their traffic light cut-out. Say **Let's think about our work in this unit.** Point to the green circle, nod your head, smile a lot, and say **I can ask *Where's my (pen): Yes, I can do this very well.*** Point to the yellow circle, move your head a little, smile a little and say **Yes, I can do this.** Then point to the red circle, shake your head and say **No, I can't do this.**
- Read the different statements. For each one, the pupils point to the colour on their traffic light that shows how they feel about their own learning.

Self-assessment statements

1. I can say the names of the classroom objects.
2. I can ask *Where's my pen?*
3. I listen to the teacher and my friends.
4. I put my hand up to speak.
5. I tidy up my things.

Recycled vocabulary

- The pupils look at the number and write the word. If necessary, they look back at the previous unit.

Answer: seven

Ending the lesson

Review the task flashcards.

- Point to the task flashcards. Say **Look at the activities you've done today. Which activity was your favourite?** Elicit the pupils' favourite activities.

Key Competences and Key Learning Outcomes



- Watch and understand a video about what children do at school
- Identify what's in your school bag



- Understand the importance of being organised

Key language

- *ball, book, box, classroom, desk, pencil case, ruler, run, school bag, sing songs, snack, water*

Materials

- Pupil's Book p17; Activity Book p14; Class CD1; Video; Teacher's App on Navio
- Teacher's Resource Bank: Task flashcards: *number, listen, Talk Partners, draw, think, say, tick, circle*
- Classroom objects flashcards

Optional materials

- Teacher's Resource Bank: Trinity Exam Practice cards (selected from Unit 1)

At a Glance Lesson Plan

Starting the lesson

- Use the Trinity Exam Practice cards (optional).
- **Think-Pair-Share**
Review school rules.
- Set learning outcomes and use the task flashcards.

Pre-watching activity

- Play *Here!* to review classroom objects.
- Look at the photo and talk about what the pupils do at school.

Activity 1

- Watch the video.
- ▶ *Unit 1 video p277*
- Number the pictures.

Activity 2

- Watch the video again.
- ▶ *Unit 1 video*
- Read and tick (✓) or cross (X).

Pupil's Book

21 CHANNEL Video and 21st Century Skills 1

Welcome to Channel 21! This programme is about school. What do you do at school?

1 Watch the video. Number the pictures. ◀

2 Watch the video again. Read and tick (✓) or cross (X). ◀

1 The children read stories. 3 The children run in the classroom.
2 The children sing songs. 4 The children put books in the box.

3 Read and circle. ◀

Being organised

1 I put my ruler / rubber in my school bag. 2 I put my book / pencil case in my school bag.
3 I put my book / ball in my school bag. 4 I put my water / snack in my school bag.

It's important to prepare your school bag.

Key learning outcomes: watch and understand a video about school in Britain
Ways of working: being organised

seventeen 17

Activity 3

- Read and circle.
- ▶ Go to the Activity Book.

Ending the lesson

- Review the lesson.
- Review the task flashcards. Elicit the pupils' favourite activities at school.

Extra activity

- Pupils make a daily tick chart to remind them what to put in their school bag.

Cooperative learning

- Talk about being organised.

Digital resources

Teacher's Digital: Don't forget you can teach this lesson using the Teacher's App on Navio.

Pupil's Digital: Encourage your pupils to use the Pupil's App on Navio to practise the vocabulary from this lesson.



Activity Book

1 Video and 21st Century Skills Being organised

1 What's missing in the school bag? Listen and circle.

1

2

3

4

▶ *Unit 1 video* What's in your school bag?

2 Read and tick (✓). Draw, point and say.

1 book
2 snack
3 pencil case
4 water
5 ruler

fourteen 3

Activity Book

Activity 1

- What's missing in the school bag? Listen and circle.
- ▶ *CD1 Track 27 p258*



Activity 2

- Read and tick (✓). Draw, point and say.
- **Recycled vocabulary**
Look, remember and write the numeral.

Detailed Lesson Plan

Starting the lesson

Use the Trinity Exam Practice cards (optional).

- The pupils practise asking and answering questions.
-  **Think-Pair-Share** Review class rules.
- Ask **Can you remember the six class rules?**
-  **Talk Partners** The pupils work with a Talk Partner to name the rules. Invite different Talk Partners to say a different rule. Write the rule on the board.

Set learning outcomes and use the task flashcards.

- Say **Today we're going to watch a video and then ask and answer questions about school.**
- Explain to pupils that each video will cover a different topic. Point to the task flashcards throughout to elicit activities and reinforce your instructions.

Pre-watching activity

- Play *Here!* with the classroom objects flashcards (see p23).
- Look at the photo of Abby, Sophie and Tom and explain that these are the presenters of Channel 21. Ask **What do you do at school?** Elicit responses.

Pupil's Book Activity 1

Watch the video. Number the pictures?  p277

- Ask **What is the video about?** Play Part 1, pausing after Sophie says, *Today's programme is about our school.*
- Ask **Where are the children? What are they doing? What can you see?** Then say **Let's watch and listen.**
- Play Part 2 of the video pausing after the first video still. Ask the pupils to point to the corresponding photo in their book.
- Play the rest of Part 2 for pupils to write the numbers in order of the photos.
- Ask **What do Sophie and Tom do at school? What do they take to school?**

Answers: 3, 2, 4, 1

Pupil's Book Activity 2

Watch the video again. Read and tick (✓) or cross (x).

-  Play Part 2 again. Pause after Sophie says, *This is our classroom.* Read out the first sentence in Activity 2. Ask **Is the desk green?** Show the tick in the circle.
- Play Part 2. Pupils tick or cross the sentences.
- Ask general questions to check understanding.
 - When do the children put their hands up?** (*To speak.*)
 - What do the children do at home time?** (*Tidy the classroom.*)
 - Is Sophie ready for school?** (*Yes.*) **Why?** (*Her things are in her school bag.*)
 - Is Tom ready for school?** (*No.*) **Why not?** (*His things aren't in his school bag.*)

Answers: 1 ✓ 2 ✓ 3 × 4 ×

Pupil's Book Activity 3

Read and circle.

- Point to the pictures to elicit the vocabulary.
- Read out number one, including the circled word.
- The pupils read the other sentences and circle the words.
-  **Think-Pair-Share** Ask **Why is it important to prepare your school bag? When do you prepare your school bag? Who prepares your school bag?**

Answers: 1 ruler 2 pencil case 3 book 4 snack

Activity Book

Activity 1

What's missing in the school bag? Listen and circle.

► CD1 Track 27 p258

- Ask **What can you see?**
- Play the first exchange on the CD. Ask **What's missing?** Play the rest of the CD, pausing for pupils to circle the missing object.

Answers: 1 book 2 water 3 ruler 4 pencil case

Activity 2

Read and tick (✓). Draw, point and say.

- Ask a few pupils **What's in your school bag?** The pupils tick the things they have got in their school bag and then draw them.

 **Talk Partners** In pairs, pupils take turns to ask and answer **What's in your school bag?**

 **Recycled vocabulary**

- Pupils look at the numeral and write it on the line.

Answers: three

Ending the lesson

Review the lesson.

- Ask **Which activity was easy / difficult?**

Review the task flashcards.

- Say **Look at the activities you've done today. Which activity was your favourite?**

Extra activity

Extension

- On the board draw a table with seven columns. On the top row write the days of the week. Ask the pupils to copy the table into their notebooks. In the first column, tell them to write a list of things they have to put in their school bag. Explain that every day they check their list and tick the things they put in their school bag.

Cooperative learning

Being organised

- Ask the pupils to tell you other times that it's important to be organised. For example, keeping the classroom tidy, doing their homework or packing a suitcase for a holiday.

Date: _____

Unit: _____

1 What did my pupils learn in this unit?

2 How did my pupils work? (✓)

individually in pairs in small groups
 in large groups as a class

3 Which key competences did my pupils develop?Competence in linguistic communication Competence in mathematics, science and technology Digital competence Learning to learn Social and civic competences Sense of initiative and entrepreneurship Cultural awareness and expression **4 Which lessons / activities were the most successful and why?**

5 Which lessons / activities did my pupils find the most difficult and why?

6 What did I try in the classroom for the first time? How did it go?

7 Which resources did I find most useful? (including webpages)

8 What could I do differently next time I teach this unit?
